

# Shadow Pricing, Direct Price Effects

## 1. Shadow Pricing

[C&B Ch. 5; DoF Ch. 3; FP Ch. 1.6, 6; S&W Ch. 8]

The NPV formula can be written as

$$NPV = \sum_t \frac{b(t) - c(t)}{(1 + r)^t}$$

where  $b(t) = \sum_i b_i p_i = b_0 p_0 + b_1 p_1 + b_2 p_2 + \dots$

and  $c(t) = \sum_j c_j p_j = \dots$

# Shadow Pricing, Direct Price Effects

## 1. Shadow Pricing

[C&B Ch. 5; DoF Ch. 3; FP Ch. 1.6, 6; S&W Ch. 8]

The NPV formula can be written as

$$NPV = \sum_t \frac{b(t) - c(t)}{(1 + r)^t}$$

where  $b(t) = \sum_i b_i p_i = b_0 p_0 + b_1 p_1 + b_2 p_2 + \dots$

and  $c(t) = \sum_j c_j p_j = \dots$

Now, we assume here that we have the the quantities  $b_i$  benefits and  $c_j$  costs.

# Shadow Pricing, Direct Price Effects

## 1. Shadow Pricing

[C&B Ch. 5; DoF Ch. 3; FP Ch. 1.6, 6; S&W Ch. 8]

The NPV formula can be written as

$$NPV = \sum_t \frac{b(t) - c(t)}{(1 + r)^t}$$

where  $b(t) = \sum_i b_i p_i = b_0 p_0 + b_1 p_1 + b_2 p_2 + \dots$

and  $c(t) = \sum_j c_j p_j = \dots$

Now, we assume here that we have the the quantities  $b_i$  benefits and  $c_j$  costs.

What of the prices  $p_i$  and  $p_j$ ?

## We want the true costs and benefits.

True prices reflect opportunities forgone (by suppliers, by consumers)

→ *shadow prices*.

A *shadow price* better approximates the true *opportunity cost* or *marginal valuation* of a product or resource or service.

## We want the true costs and benefits.

True prices reflect opportunities forgone (by suppliers, by consumers)

→ *shadow prices*.

A **shadow price** better approximates the true *opportunity cost* or *marginal valuation* of a product or resource or service.

Five cases in which market prices are distorted, so that we must dig a little to obtain the shadow price, the true opportunity cost or valuation:

- 1.

## We want the true costs and benefits.

True prices reflect opportunities forgone (by suppliers, by consumers)

→ *shadow prices*.

A **shadow price** better approximates the true *opportunity cost* or *marginal valuation* of a product or resource or service.

Five cases in which market prices are distorted, so that we must dig a little to obtain the shadow price, the true opportunity cost or valuation:

1. of a tax,
- 2.

## We want the true costs and benefits.

True prices reflect opportunities forgone (by suppliers, by consumers)

→ *shadow prices*.

A **shadow price** better approximates the true *opportunity cost* or *marginal valuation* of a product or resource or service.

Five cases in which market prices are distorted, so that we must dig a little to obtain the shadow price, the true opportunity cost or valuation:

1. of a tax,
2. of a price change,
- 3.

## We want the true costs and benefits.

True prices reflect opportunities forgone (by suppliers, by consumers)

→ *shadow prices*.

A **shadow price** better approximates the true *opportunity cost* or *marginal valuation* of a product or resource or service.

Five cases in which market prices are distorted, so that we must dig a little to obtain the shadow price, the true opportunity cost or valuation:

1. of a tax,
2. of a price change,
3. of a tax with a price change,
- 4.



## We want the true costs and benefits.

True prices reflect opportunities forgone (by suppliers, by consumers)

→ *shadow prices*.

A **shadow price** better approximates the true *opportunity cost* or *marginal valuation* of a product or resource or service.

Five cases in which market prices are distorted, so that we must dig a little to obtain the shadow price, the true opportunity cost or valuation:

1. of a tax,
2. of a price change,
3. of a tax with a price change,
4. of unemployment with minimum wages,
- 5.

## We want the true costs and benefits.

True prices reflect opportunities forgone (by suppliers, by consumers)

→ *shadow prices*.

A **shadow price** better approximates the true *opportunity cost* or *marginal valuation* of a product or resource or service.

Five cases in which market prices are distorted, so that we must dig a little to obtain the shadow price, the true opportunity cost or valuation:

1. of a tax,
2. of a price change,
3. of a tax with a price change,
4. of unemployment with minimum wages,
5. of a tariff (a tax on imports).

## Efficiency Cost-Benefit Analysis

To determine the true or shadow prices, use:

-

## Efficiency Cost-Benefit Analysis

To determine the true or shadow prices, use:

- Willingness To Pay (demand curve) for *consumption*
-

## Efficiency Cost-Benefit Analysis

To determine the true or shadow prices, use:

- Willingness To Pay (demand curve) for *consumption*
- Opportunity Costs (supply curve) for *inputs*

But beware whether quantities increase or decrease in inputs or outputs.

## Efficiency Cost-Benefit Analysis

To determine the true or shadow prices, use:

- Willingness To Pay (demand curve) for *consumption*
- Opportunity Costs (supply curve) for *inputs*

But beware whether quantities increase or decrease in inputs or outputs.

*C&B's Pricing Rule.* [C&B p.93]

Item to be valued	Valued at equilibrium point on a:	
	Demand Curve	Supply Curve
Output	Satisfies additional demand	Satisfies existing demand from alternative source
Input	Sourced from an alternative market source	Sourced from additional supply

(See also the Table on p.30 of the DoF *Handbook*.)

## The Area under the Demand Curve is the Value of that Quantity

A demand curve shows the maximum the buyer is prepared to pay for each unit bought. As the price rises, buyers choose to buy less. They forgo the value to them of buying and using the forgone quantity: area = value forgone, as price  $P_1 \rightarrow P_2$ .

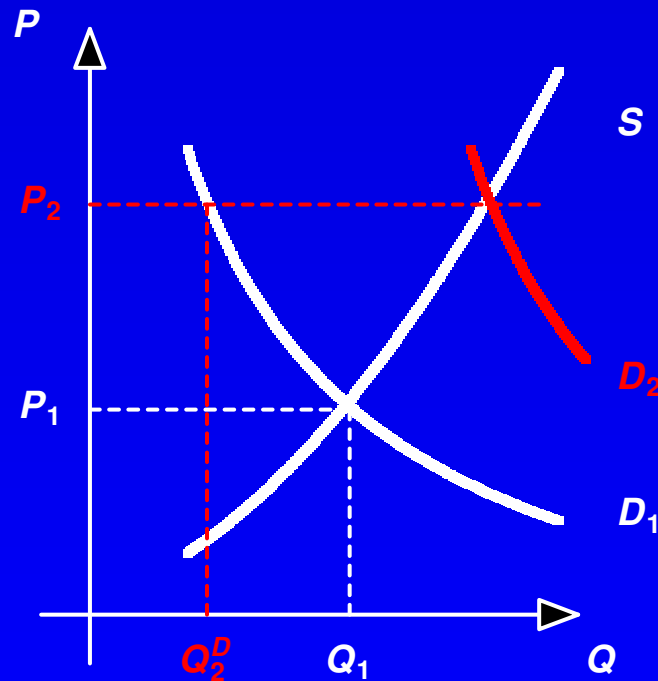

## The Area under the Demand Curve is the Value of that Quantity

A demand curve shows the maximum the buyer is prepared to pay for each unit bought. As the price rises, buyers choose to buy less. They forgo the value to them of buying and using the forgone quantity: area = value forgone, as price  $P_1 \rightarrow P_2$ .

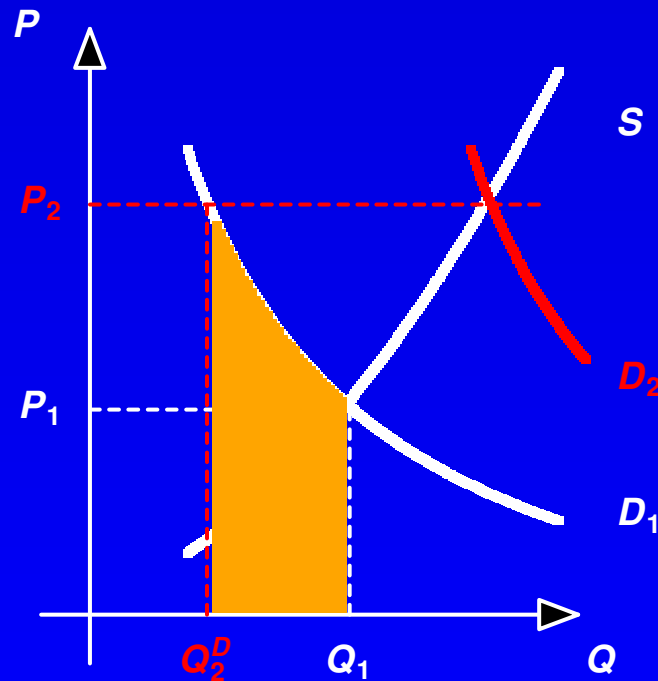

**Remember: the value of the last unit bought (the marginal value to the buyer) = the price of that unit.**



## The Area under the Supply Curve is the Cost of that Quantity

To a firm in a competitive market, its supply curve shows the cost of supplying each unit. A higher price induces more units to be offered for sale: the area under the supply curve is the total cost of supplying those units, as price  $P_1 \rightarrow P_2$ .

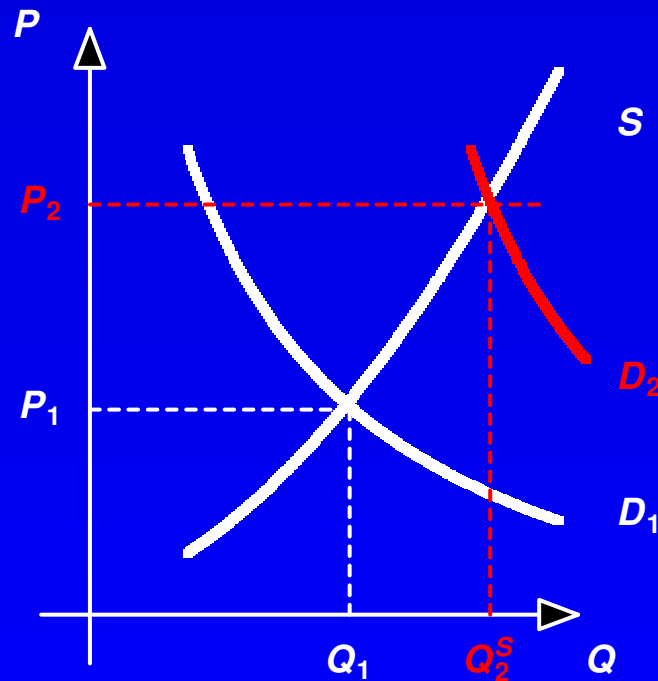

## The Area under the Supply Curve is the Cost of that Quantity

To a firm in a competitive market, its supply curve shows the cost of supplying each unit. A higher price induces more units to be offered for sale: the area under the supply curve is the total cost of supplying those units, as price  $P_1 \rightarrow P_2$ .

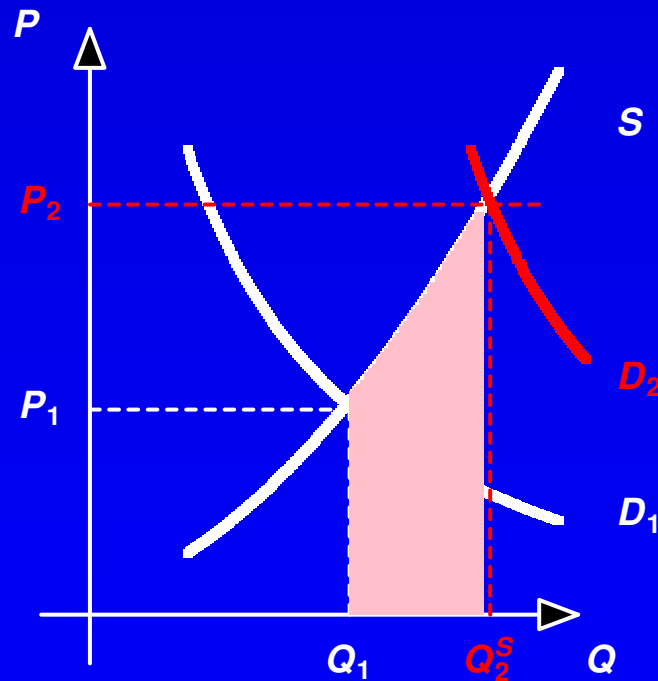

**Remember: the marginal cost of supply (the cost of supplying the last unit sold) = the price of that unit.**

---

*1.1 Example 1: A Tax* [C&B pp. 108–110; S&W Ch. 8.3]

Q:

---

**1.1 Example 1: A Tax** [C&B pp. 108–110; S&W Ch. 8.3]

**Q:** A remote electricity-generation project pays \$1/litre for its fuel oil, the costliest input to the project. The FA (financial appraisal) gives an NPV close to zero, but there is a tax on the fuel oil of 45¢/litre. What is the shadow price of fuel oil, to be used in the CBA NPV?

**1.1 Example 1: A Tax** [C&B pp. 108–110; S&W Ch. 8.3]

**Q:** A remote electricity-generation project pays \$1/litre for its fuel oil, the costliest input to the project. The FA (financial appraisal) gives an NPV close to zero, but there is a tax on the fuel oil of 45¢/litre. What is the shadow price of fuel oil, to be used in the CBA NPV?

**A:**

### 1.1 Example 1: **A Tax** [C&B pp. 108–110; S&W Ch. 8.3]

- Q:** A remote electricity-generation project pays \$1/litre for its fuel oil, the costliest input to the project. The FA (financial appraisal) gives an NPV close to zero, but there is a tax on the fuel oil of 45¢/litre. What is the shadow price of fuel oil, to be used in the CBA NPV?
- A:** Since the tax is a **transfer** (paying 45¢/litre for nothing), ignore it in a CBA. The shadow price is 55¢/litre, and the CBA NPV will be positive, because of the lower opportunity cost of fuel oil at the shadow price.

### 1.1 Example 1: **A Tax** [C&B pp. 108–110; S&W Ch. 8.3]

**Q:** A remote electricity-generation project pays \$1/litre for its fuel oil, the costliest input to the project. The FA (financial appraisal) gives an NPV close to zero, but there is a tax on the fuel oil of 45¢/litre. What is the shadow price of fuel oil, to be used in the CBA NPV?

**A:** Since the tax is a **transfer** (paying 45¢/litre for nothing), ignore it in a CBA. The shadow price is 55¢/litre, and the CBA NPV will be positive, because of the lower opportunity cost of fuel oil at the shadow price.

**A (specific) tax on a good supplied in a competitive market:**

-

### 1.1 Example 1: **A Tax** [C&B pp. 108–110; S&W Ch. 8.3]

**Q:** A remote electricity-generation project pays \$1/litre for its fuel oil, the costliest input to the project. The FA (financial appraisal) gives an NPV close to zero, but there is a tax on the fuel oil of 45¢/litre. What is the shadow price of fuel oil, to be used in the CBA NPV?

**A:** Since the tax is a **transfer** (paying 45¢/litre for nothing), ignore it in a CBA. The shadow price is 55¢/litre, and the CBA NPV will be positive, because of the lower opportunity cost of fuel oil at the shadow price.

**A (specific) tax on a good supplied in a competitive market:**

- places a wedge between the marginal cost (supply) and price (demand)

∴



### 1.1 Example 1: **A Tax** [C&B pp. 108–110; S&W Ch. 8.3]

**Q:** A remote electricity-generation project pays \$1/litre for its fuel oil, the costliest input to the project. The FA (financial appraisal) gives an NPV close to zero, but there is a tax on the fuel oil of 45¢/litre. What is the shadow price of fuel oil, to be used in the CBA NPV?

**A:** Since the tax is a **transfer** (paying 45¢/litre for nothing), ignore it in a CBA. The shadow price is 55¢/litre, and the CBA NPV will be positive, because of the lower opportunity cost of fuel oil at the shadow price.

**A (specific) tax on a good supplied in a competitive market:**

- places a wedge between the marginal cost (supply) and price (demand)
- ∴ the single (equilibrium) price  $p_0^S$  can no longer represent both valuation and cost

•

### 1.1 Example 1: **A Tax** [C&B pp. 108–110; S&W Ch. 8.3]

**Q:** A remote electricity-generation project pays \$1/litre for its fuel oil, the costliest input to the project. The FA (financial appraisal) gives an NPV close to zero, but there is a tax on the fuel oil of 45¢/litre. What is the shadow price of fuel oil, to be used in the CBA NPV?

**A:** Since the tax is a **transfer** (paying 45¢/litre for nothing), ignore it in a CBA. The shadow price is 55¢/litre, and the CBA NPV will be positive, because of the lower opportunity cost of fuel oil at the shadow price.

**A (specific) tax on a good supplied in a competitive market:**

- places a wedge between the marginal cost (supply) and price (demand)
- ∴ the single (equilibrium) price  $p_0^S$  can no longer represent both valuation and cost
- Suppose the good is an input into a project:

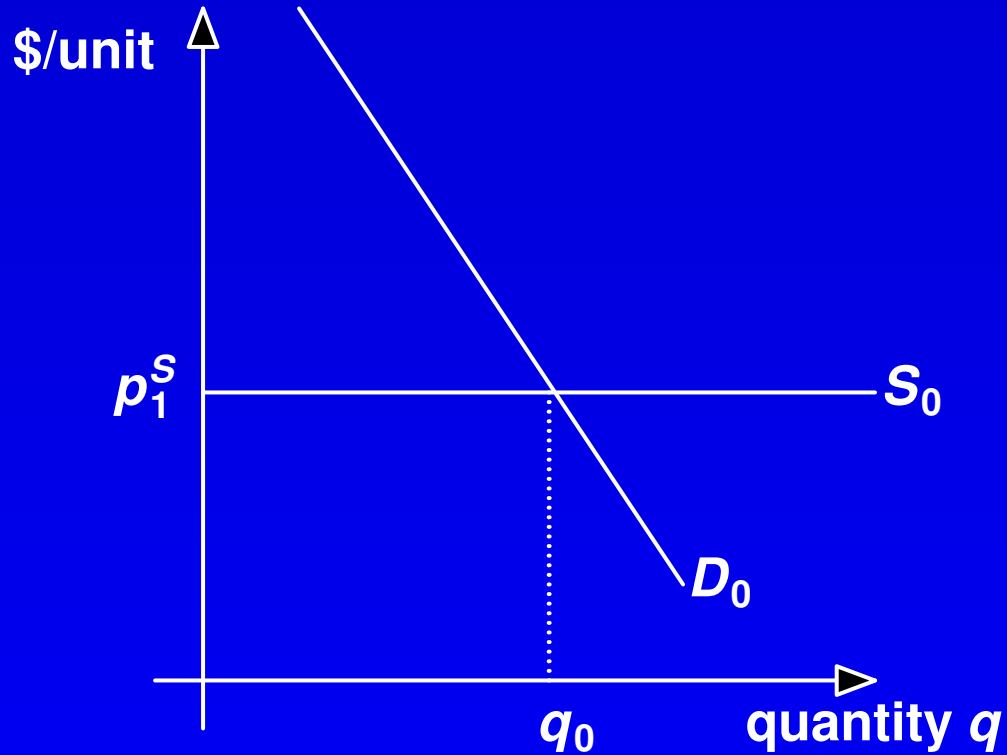
**A Tax (cont.) — Infinitely elastic supply**

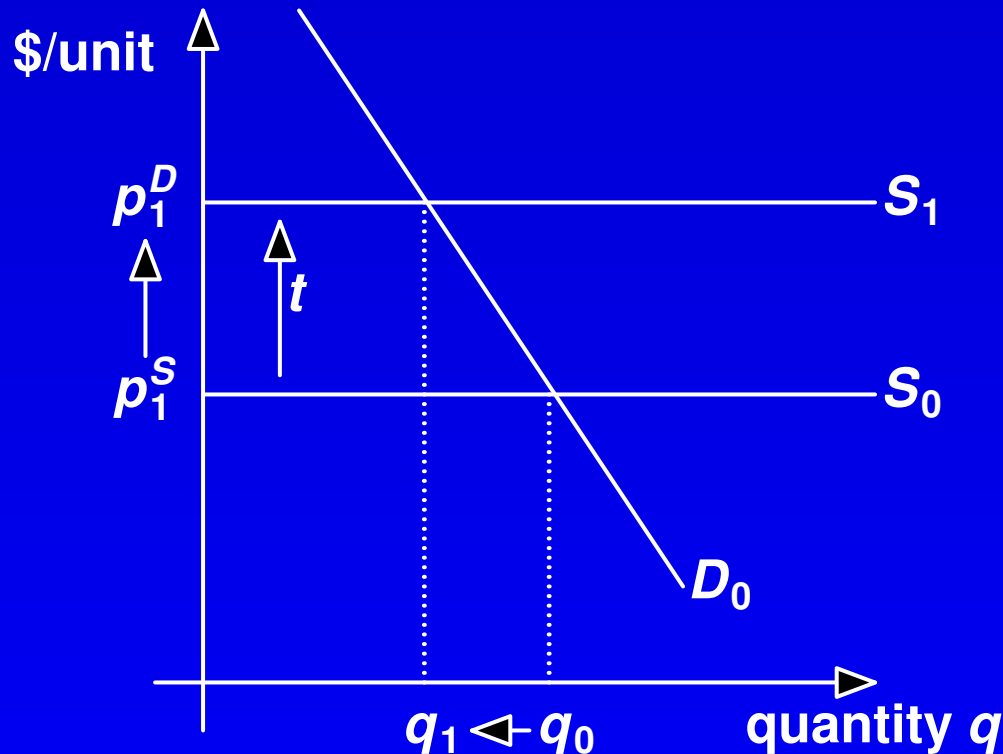
**A Tax (cont.) — Infinitely elastic supply**

Because of the tax, the (tax-inclusive) demand price  $p_1^D$  is greater than the (tax-exclusive) supply price  $p_0^S$ .

The diagram shows the Tax Revenue and the Dead-Weight Loss as the tax is imposed, pushing up the effective supply, and reducing the quantity demanded, from  $q_0$  to  $q_1$ .

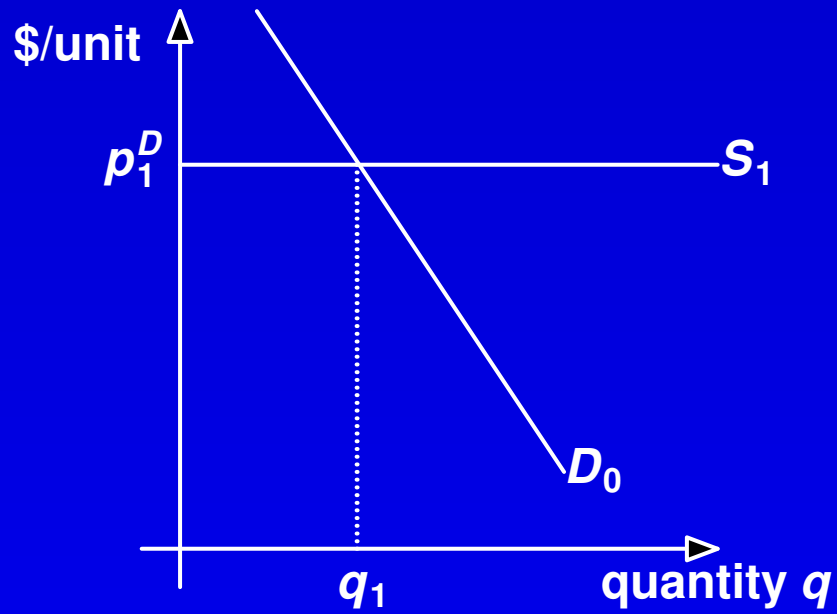
**A Tax (cont.)**

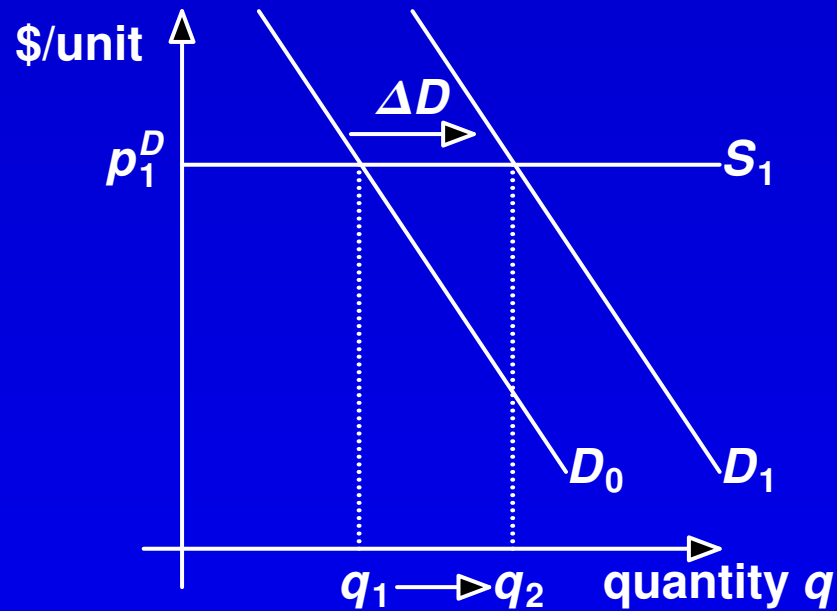
**A Tax (cont.)**

Let's say the project results in an expansion of demand, from  $D_0$  to  $D_1$ .

•

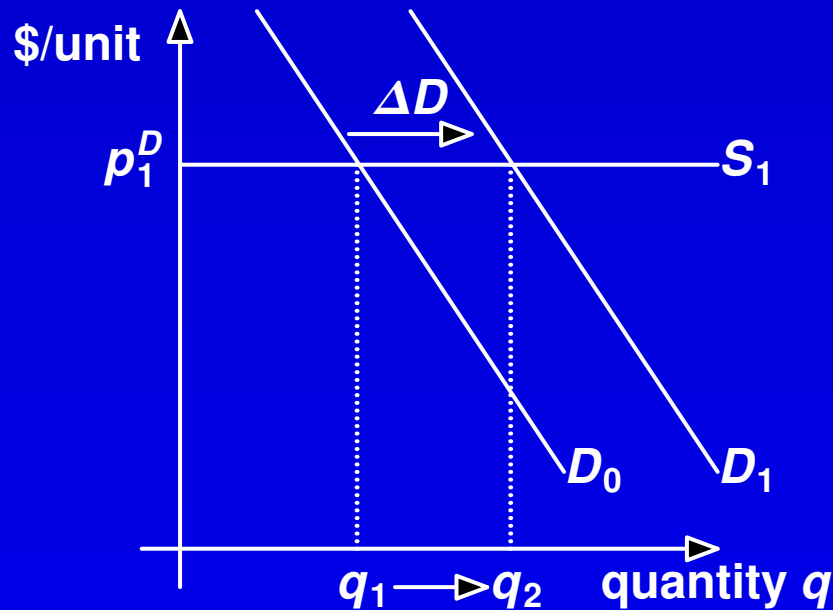
**A Tax (cont.)**

Let's say the project results in an expansion of demand, from  $D_0$  to  $D_1$ .

- But there is no change in  $p_1^D$  with the increase in demand.
-

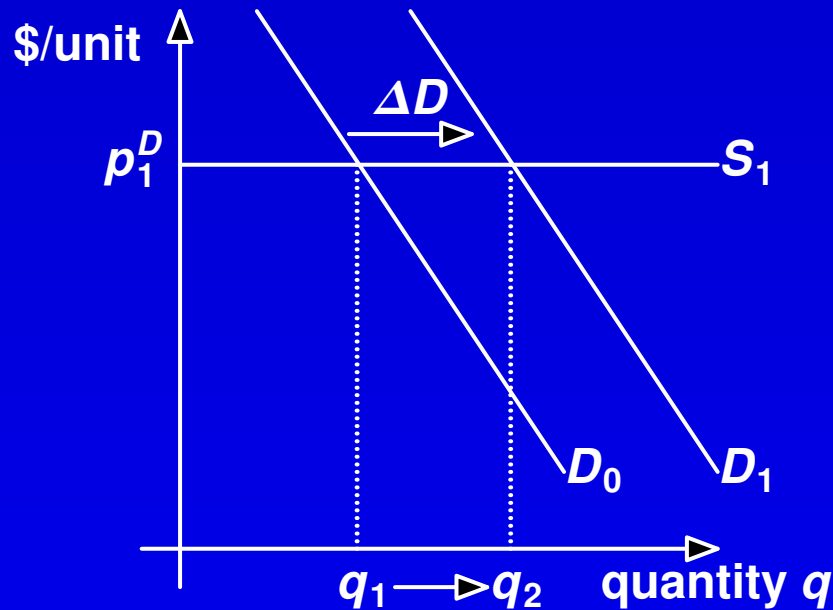
**A Tax (cont.)**

Let's say the project results in an expansion of demand, from  $D_0$  to  $D_1$ .

- But there is no change in  $p_1^D$  with the increase in demand.
- Because of the tax, the project pays the higher, tax-inclusive price  $p_1^D$ .
-

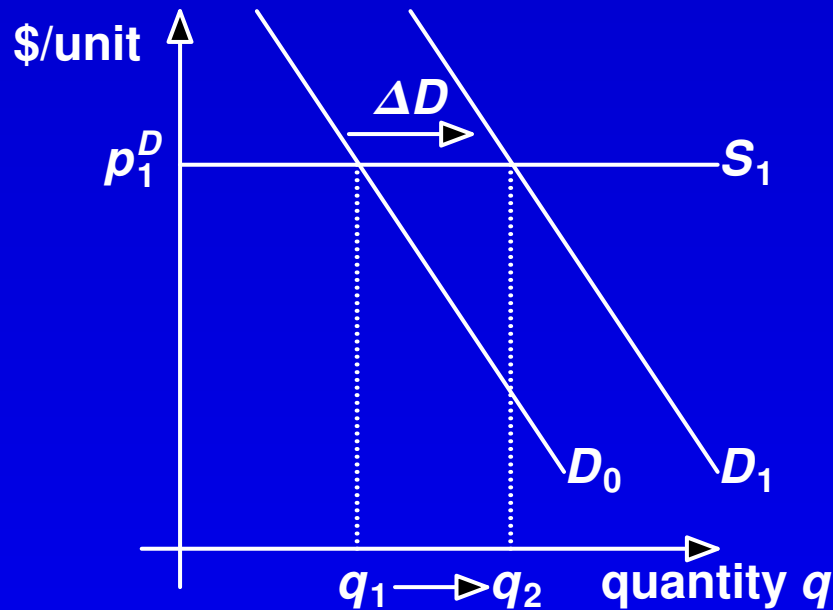

**A Tax (cont.)**

Let's say the project results in an expansion of demand, from  $D_0$  to  $D_1$ .

- But there is no change in  $p_1^D$  with the increase in demand.
- Because of the tax, the project pays the higher, tax-inclusive price  $p_1^D$ .
- Is this *the shadow price*?
-

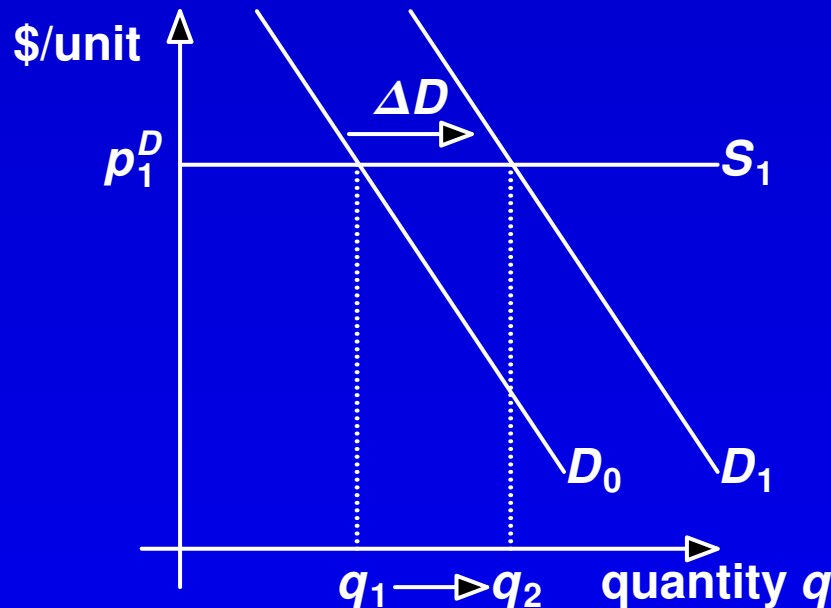
**A Tax (cont.)**

Let's say the project results in an expansion of demand, from  $D_0$  to  $D_1$ .

- But there is no change in  $p_1^D$  with the increase in demand.
- Because of the tax, the project pays the higher, tax-inclusive price  $p_1^D$ .
- Is this *the shadow price*?
- Does  $p_1^D$  reflect the opportunity cost associated with the extra quantity?
-

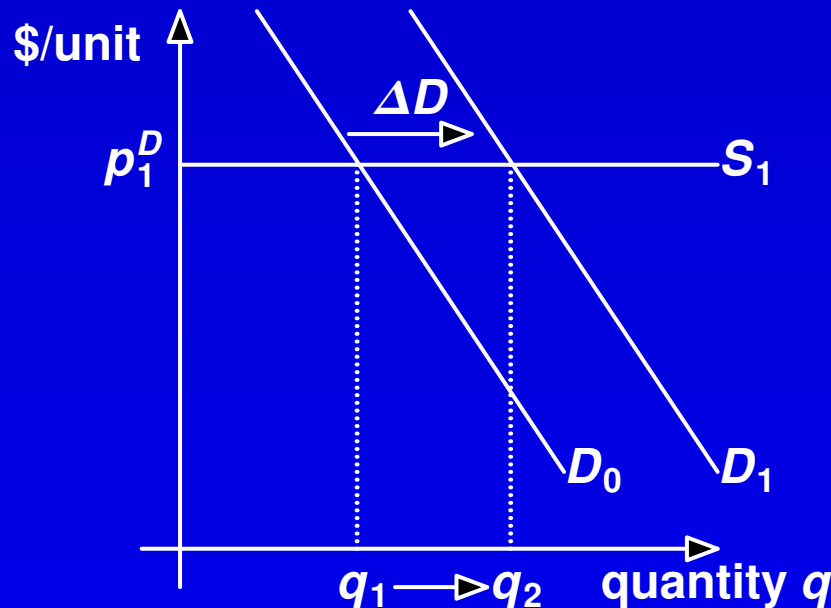
**A Tax (cont.)**

Let's say the project results in an expansion of demand, from  $D_0$  to  $D_1$ .

- But there is no change in  $p_1^D$  with the increase in demand.
- Because of the tax, the project pays the higher, tax-inclusive price  $p_1^D$ .
- Is this *the shadow price*?
- Does  $p_1^D$  reflect the opportunity cost associated with the extra quantity?
- No, in general, but it depends on the purpose of the tax (i.e., revenue or “green” tax?).

**A Tax (cont.) —**

e.g. oil at world price plus a local excise of  $t$ :

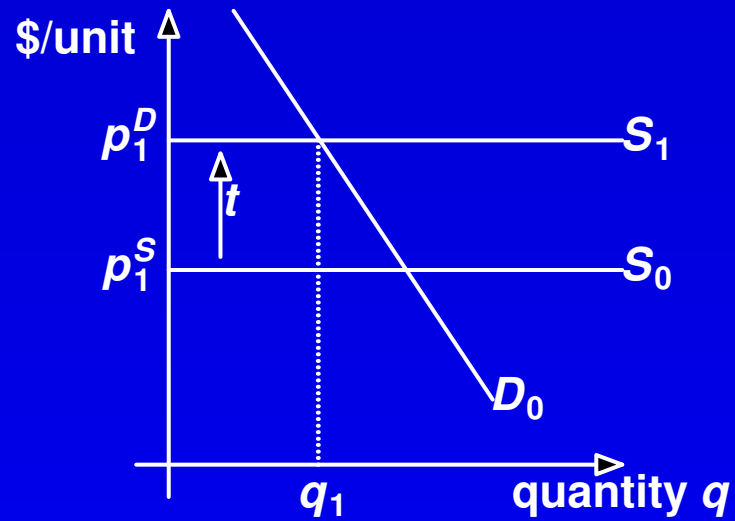

**A Tax (cont.) —**

e.g. oil at world price plus a local excise of  $t$ :

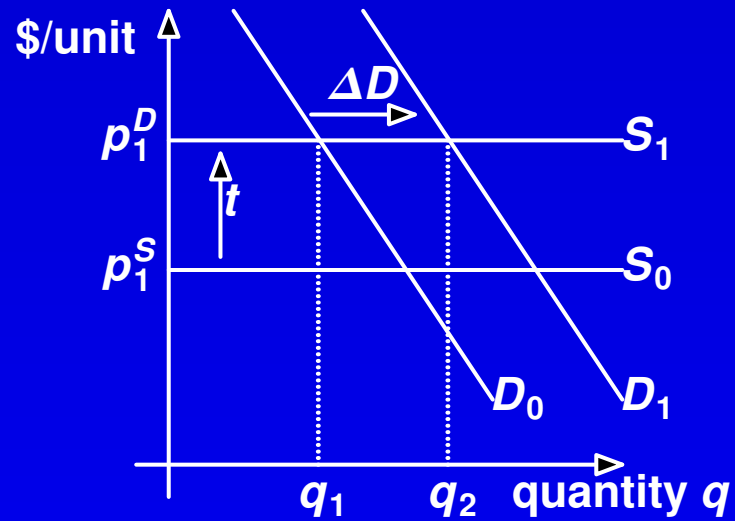

**A Tax (cont.) —**

e.g. oil at world price plus a local excise of  $t$ :

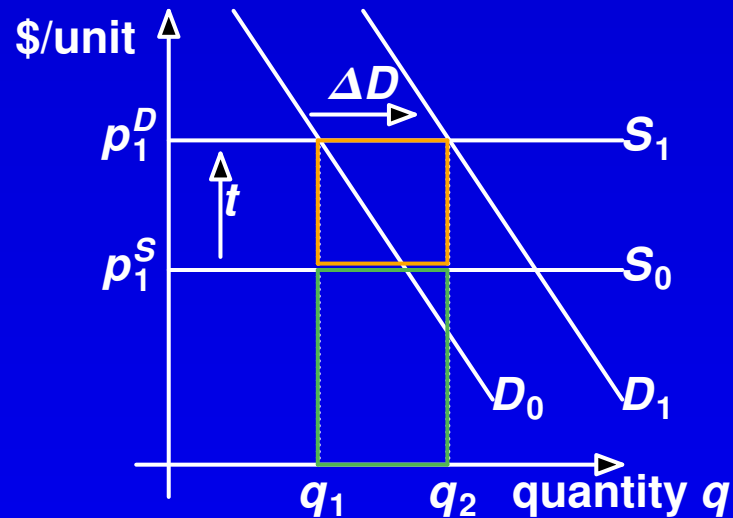

Consumers value the increase in demand ( $\Delta D$ ) at the tax-inclusive price  $p_1^D$ .

Suppliers' price is unchanged at  $p_1^S$ .

Shadow price =  $p_1^D - t = p_1^S$  = unchanging tax-exclusive price,  $p_1^S$ .

The tax revenue (□) is a **transfer**, and so changes in the tax revenue (changes in a **transfer**) are not changes in cost (□).

**A Tax (cont.) —**

e.g. oil at world price plus a local excise of  $t$ :

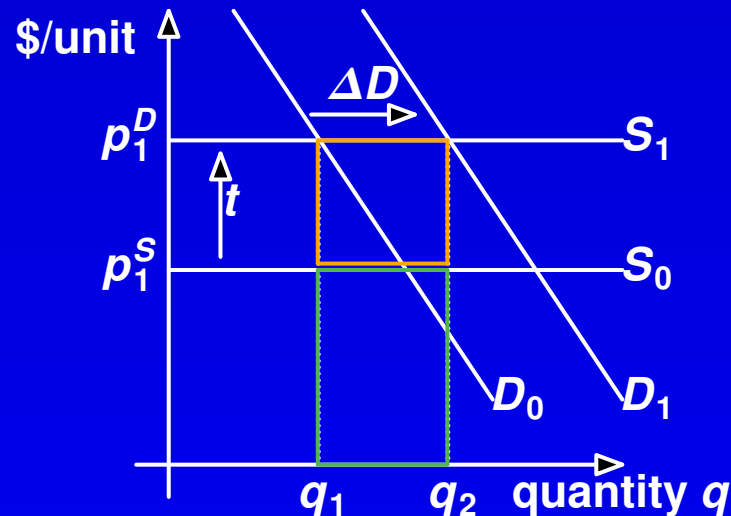

Consumers value the increase in demand ( $\Delta D$ ) at the tax-inclusive price  $p_1^D$ .

Suppliers' price is unchanged at  $p_1^S$ .

Shadow price =  $p_1^D - t = p_1^S$  = unchanging tax-exclusive price,  $p_1^S$ .

The tax revenue ( $\square$ ) is a **transfer**, and so changes in the tax revenue (changes in a **transfer**) are not changes in cost ( $\square$ ).

This is only the case if there is *no effect on existing purchasers of output*, since there is no increase in price with perfectly elastic supply.

$\therefore$  the ex-tax price  $p_1^S$  is the shadow price.

## **1.2 Example 2: Shadow prices and opportunity costs when prices change**

[C&B pp. 92–96; FP Ch. 2.2.2, 2.3.2; DoF 3.4]

Q:



## **1.2 Example 2: Shadow prices and opportunity costs when prices change**

[C&B pp. 92–96; FP Ch. 2.2.2, 2.3.2; DoF 3.4]

**Q:** There is a local market for irrigation water. The going price is \$50/megalitre. A new cotton farm is planned, but its size and thirst for water are such that the going price of water will rise to \$60/megalitre, given its demand of 10,000 megalitres/year. At the lower price the NPV of the project is positive, but at the higher price negative. At the higher price the incumbent users cut their consumption by 1000 megalitres/year.

**A:**

## 1.2 Example 2: Shadow prices and opportunity costs when prices change

[C&B pp. 92–96; FP Ch. 2.2.2, 2.3.2; DoF 3.4]

**Q:** There is a local market for irrigation water. The going price is \$50/megalitre. A new cotton farm is planned, but its size and thirst for water are such that the going price of water will rise to \$60/megalitre, given its demand of 10,000 megalitres/year. At the lower price the NPV of the project is positive, but at the higher price negative. At the higher price the incumbent users cut their consumption by 1000 megalitres/year.

**A:** The shadow price is between \$50 and \$60/megalitre, say \$55 (assuming linear supply and demand curves). The existing users bear a cost of  $\$55 \times 1000 = \$55,000$ /year for the water they can no longer afford (the *displaced* water).

## 1.2 Example 2: Shadow prices and opportunity costs when prices change

[C&B pp. 92–96; FP Ch. 2.2.2, 2.3.2; DoF 3.4]

**Q:** There is a local market for irrigation water. The going price is \$50/megalitre. A new cotton farm is planned, but its size and thirst for water are such that the going price of water will rise to \$60/megalitre, given its demand of 10,000 megalitres/year. At the lower price the NPV of the project is positive, but at the higher price negative. At the higher price the incumbent users cut their consumption by 1000 megalitres/year.

**A:** The shadow price is between \$50 and \$60/megalitre, say \$55 (assuming linear supply and demand curves). The existing users bear a cost of  $\$55 \times 1000 = \$55,000/\text{year}$  for the water they can no longer afford (the *displaced* water). The shadow cost to the new farm is \$550,000/year, which includes \$55,000 to outbid the exiting users for 1000 megalitres/year, and the opportunity cost of \$495,000 to induce the increased supply of 9000 megalitres of water (the *incremental* water).

## Prices Change (cont.)

(Not to scale.)

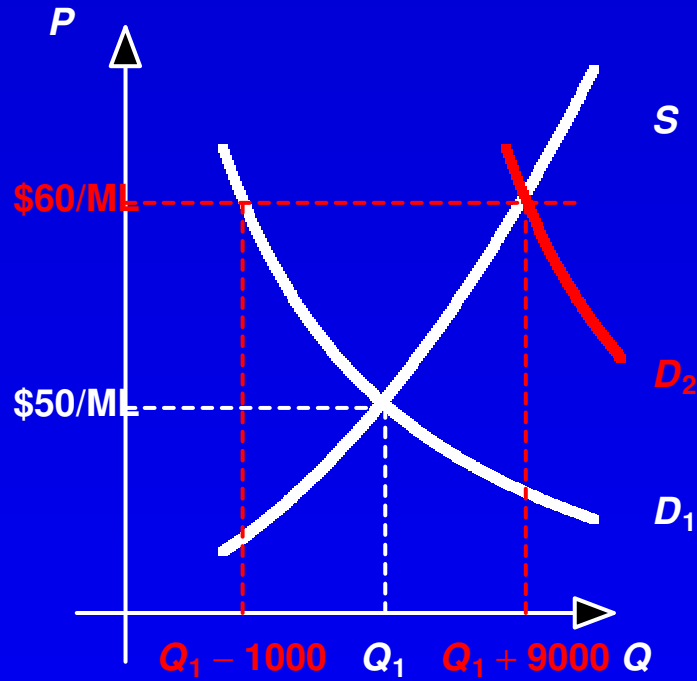

## Prices Change (cont.)

(Not to scale.)

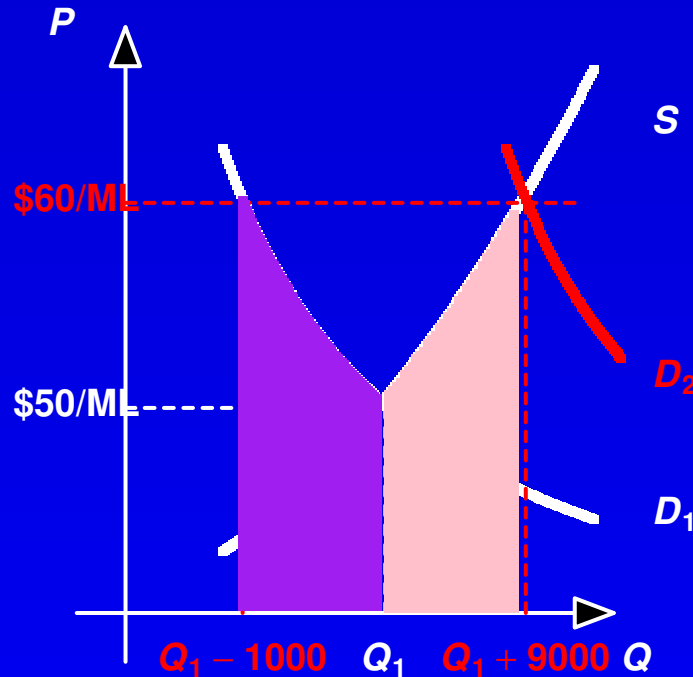

value of displaced water = \$55,000  
 cost of supplying incremental water = \$495,000  
 $\therefore$  total cost = \$550,000  $\rightarrow P_S = \$55$

**For a FA, cost =  $\$60 \times 10,000 = \$600,000$**

**For a CBA, cost =  $\$55 \times 10,000 = \$550,000$**

## Prices Change (cont.)

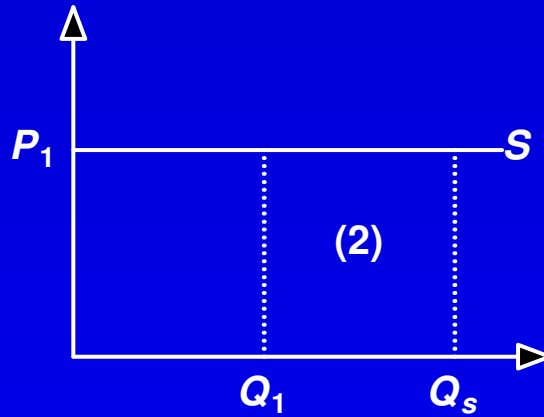

$\Delta G$

Case 2.1

(No price change)

## Prices Change (cont.)

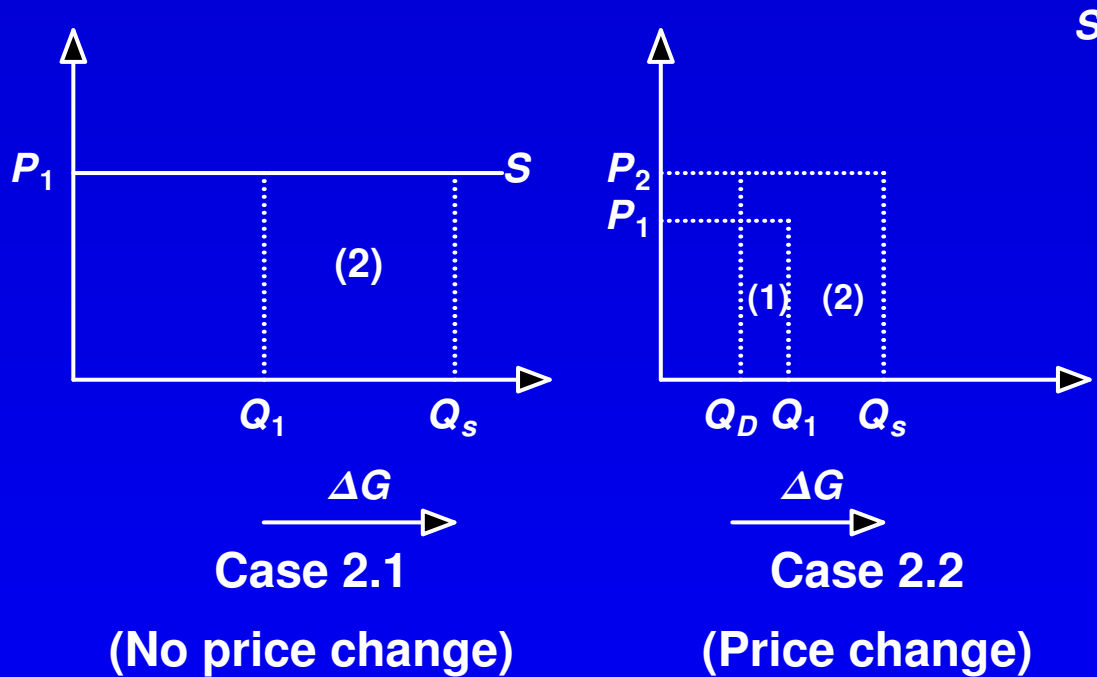

**Case 2.1: (No price change)**

**resource opportunity cost = total social costs for  
 increased factor supply (2)  
 =  $P_1 \cdot \Delta G$**

**Case 2.2: (Price change)**

**resource opportunity cost = total social costs**  
 $P_1 \cdot \Delta G$  **for increased factor supply (2)**

**+ value of reduced use of inputs  
 in the rest of society as a  
 response to higher prices,  
 or opportunity costs. (1)**

$$P_1 \cdot \Delta G < \text{Area [(1) + (2)]} < P_2 \cdot \Delta G$$

$$\therefore P_1 < P_s < P_2$$

→  $P_s$  is the “effective or shadow price”:

$P_s \cdot \Delta G$  is the resource cost = area (1) + area (2)



**Prices Change (cont.)**

**Note: be conservative**

**if NPV > 0 with  $P_2 \sim$  cost**

**then GO**

## **Prices Change (cont.)**

**Note: be conservative**

if NPV > 0 with  $P_2 \sim$  cost then **GO**

if NPV < 0 with  $P_1 \sim$  cost then **STOP**

## Prices Change (cont.)

Note: be conservative

if NPV > 0 with  $P_2 \sim$  cost then GO

if NPV < 0 with  $P_1 \sim$  cost then STOP

if  $\left\{ \begin{array}{l} NPV(P_2) < 0 \\ NPV(P_1) > 0 \\ NPV(P_s) ? \end{array} \right.$  then must find  $P_s$

The point is so avoid the cost and effort of deriving a better estimate of the shadow price  $P_s$  if it won't make any difference to the decision.

## Some Equations and Harberger's Method

### Area under Demand Curve

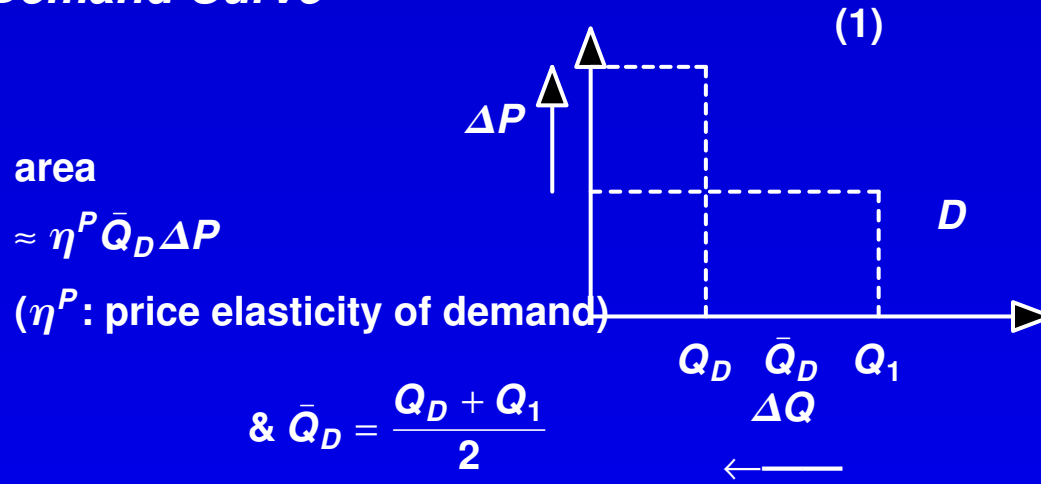

## Some Equations and Harberger's Method

### Area under Demand Curve

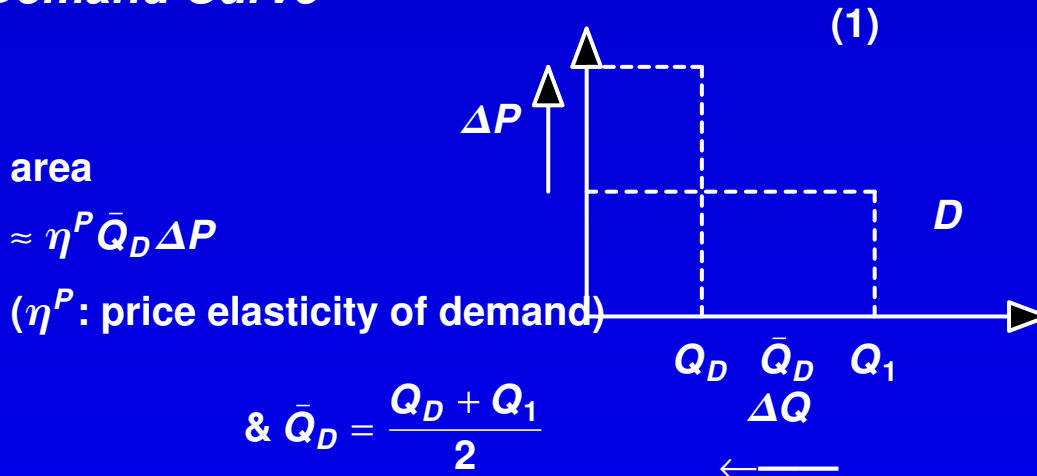

$$\& \bar{Q}_D = \frac{Q_D + Q_1}{2}$$

### Area under Supply Curve

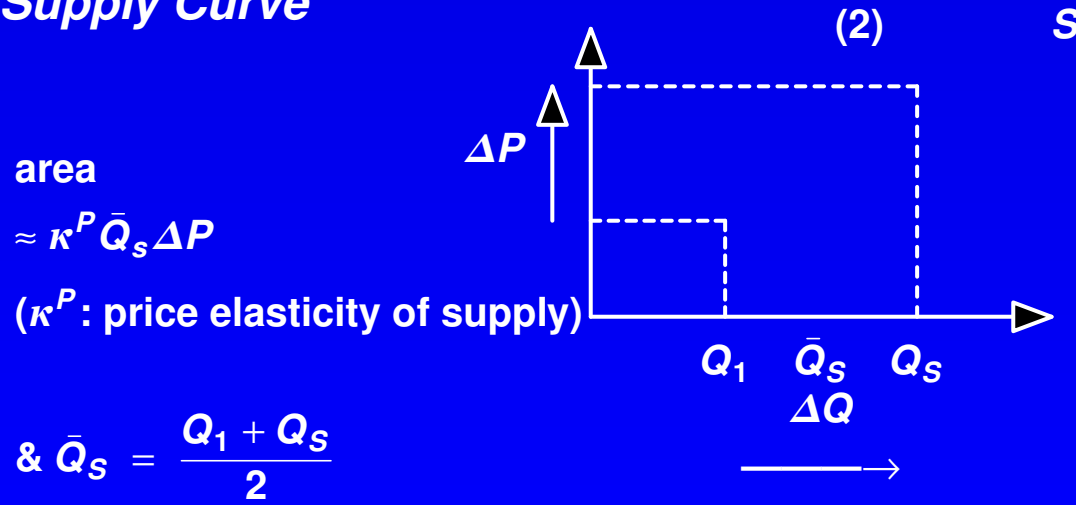

$$\& \bar{Q}_S = \frac{Q_1 + Q_S}{2}$$

**Case 2.2: Prices change.** (NFX: Not For Exam)

From above, social cost (1) + (2) =  $P_s \cdot \Delta G$

$$= \Delta P (\eta \bar{Q}_D + \kappa \bar{Q}_S)$$

$$\therefore P_s = \frac{\Delta P (\eta \bar{Q}_D + \kappa \bar{Q}_S)}{\Delta G} \quad \text{shadow price}$$

$$= \frac{\Delta P \left( \eta \frac{Q_1 + Q_D}{2} + \kappa \frac{Q_1 + Q_S}{2} \right)}{\Delta G}$$

$$= \frac{\Delta P \eta \left( Q_1 + \frac{Q_D}{2} + \frac{Q_S}{2} \right)}{\Delta G} \quad (\text{if } \eta = \kappa)$$

— a means of obtaining the shadow price  $P_s$  from  $Q_1$ ,  $\Delta P$ ,  $\eta$ ,  $\kappa$ ,  $Q_D$ ,  $Q_S$ , and  $\Delta G$ .

## The Project's Output Drives Prices Down

The project produces an output which is sold: FA benefit = revenue = selling price  $\times$  quantity. With no change in price, same with CBA. If the output price falls, some marginal producers cut back or cease: a benefit. **FA revenue** is too low.

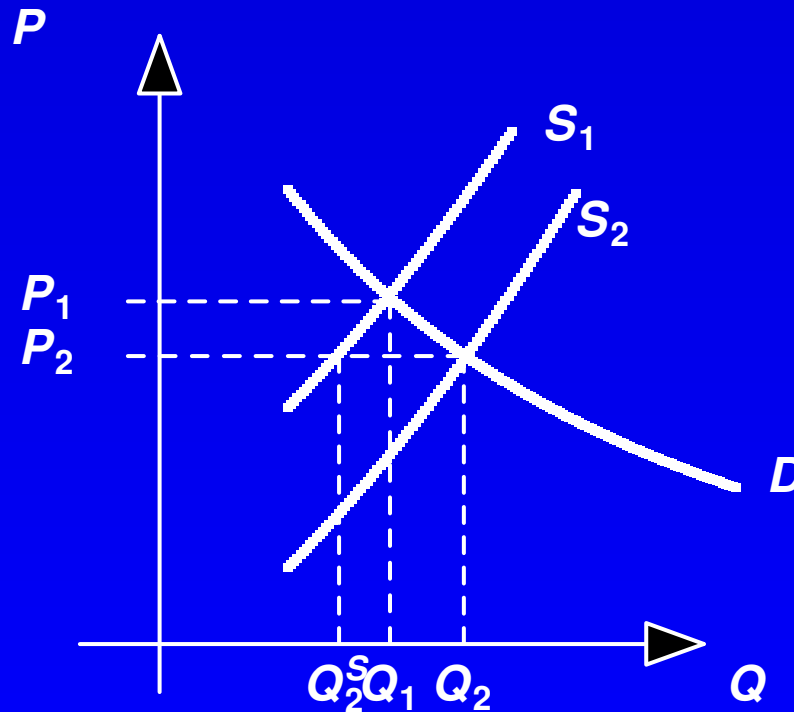

## The Project's Output Drives Prices Down

The project produces an output which is sold: FA benefit = revenue = selling price  $\times$  quantity. With no change in price, same with CBA. If the output price falls, some marginal producers cut back or cease: a benefit. **FA revenue** is too low.

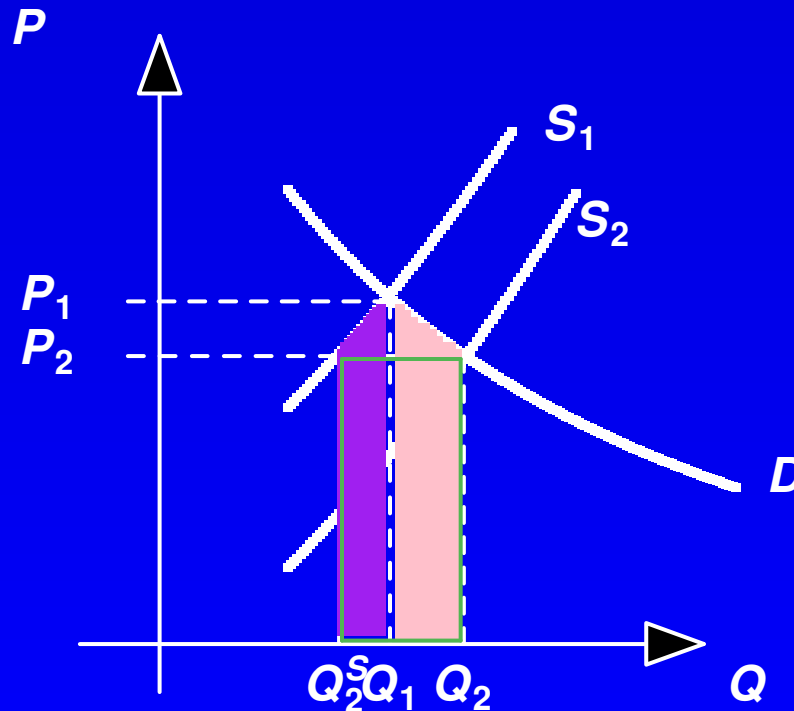

value of the displaced production  
 value of the incremental production  
 $P_1 < \text{shadow price} < P_2$



---

**1.3 Example 3: Prices change with a tax wedge. [DoF 3.5]**

**Q:**

---

**1.3 Example 3: Prices change with a tax wedge. [DoF 3.5]**

**Q:** In the cotton-farm example, assume that the prices of \$50 (before) and \$60/megalitre (after) include a tax of \$4/megalitre, to raise revenue. What now is the shadow cost of water to the new farm?

**A:**

---

**1.3 Example 3: Prices change with a tax wedge. [DoF 3.5]**

- Q:** In the cotton-farm example, assume that the prices of \$50 (before) and \$60/megalitre (after) include a tax of \$4/megalitre, to raise revenue. What now is the shadow cost of water to the new farm?
- A:** We have to adjust for both the induced price increase and the tax wedge between suppliers of water and users of water.

### 1.3 Example 3: Prices change with a tax wedge. [DoF 3.5]

**Q:** In the cotton-farm example, assume that the prices of \$50 (before) and \$60/megalitre (after) include a tax of \$4/megalitre, to raise revenue. What now is the shadow cost of water to the new farm?

**A:** We have to adjust for both the induced price increase and the tax wedge between suppliers of water and users of water.

The value of the *displaced* 1000 megalitres of water for the existing farmers who cannot afford to pay \$60/megalitre is still \$55,000 year: we use the tax-inclusive price of \$55/megalitre because they evidently value this water at \$50/megalitre at least, but not at \$60/megalitre.

### 1.3 Example 3: Prices change with a tax wedge. [DoF 3.5]

**Q:** In the cotton-farm example, assume that the prices of \$50 (before) and \$60/megalitre (after) include a tax of \$4/megalitre, to raise revenue. What now is the shadow cost of water to the new farm?

**A:** We have to adjust for both the induced price increase and the tax wedge between suppliers of water and users of water.

The value of the *displaced* 1000 megalitres of water for the existing farmers who cannot afford to pay \$60/megalitre is still \$55,000 year: we use the tax-inclusive price of \$55/megalitre because they evidently value this water at \$50/megalitre at least, but not at \$60/megalitre.

The shadow cost of the *incremental* water is between \$46 and \$56/megalitre (the tax-exclusive prices), since that's what the suppliers of water receive to induce them to increase supply; say  $\$51 \times 9000$  megalitres/year = \$459,000/year.

∴ Total shadow cost = \$55,000 + \$459,000 = 514,000/year.

∴ Shadow price = \$51.40/megalitre

## Price Change & Tax (cont.)

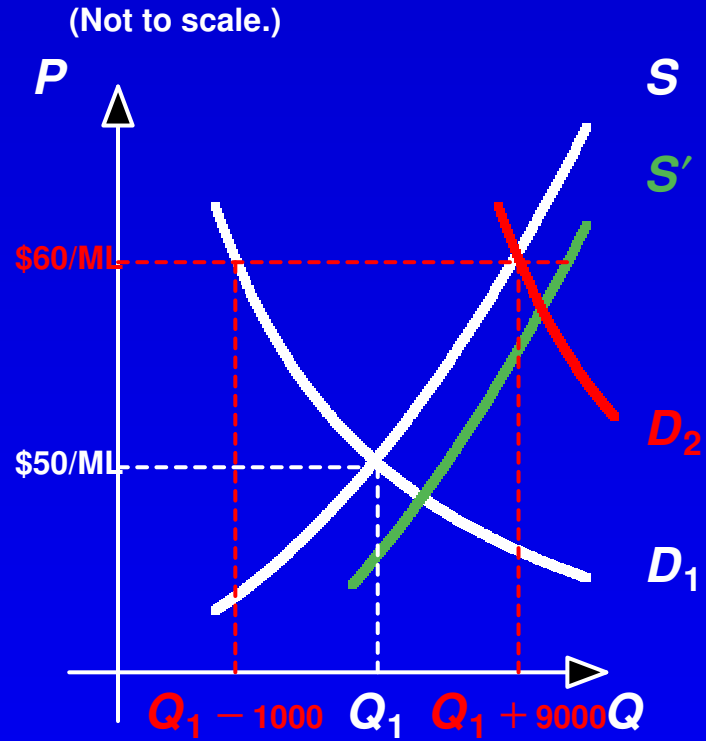

## Price Change & Tax (cont.)

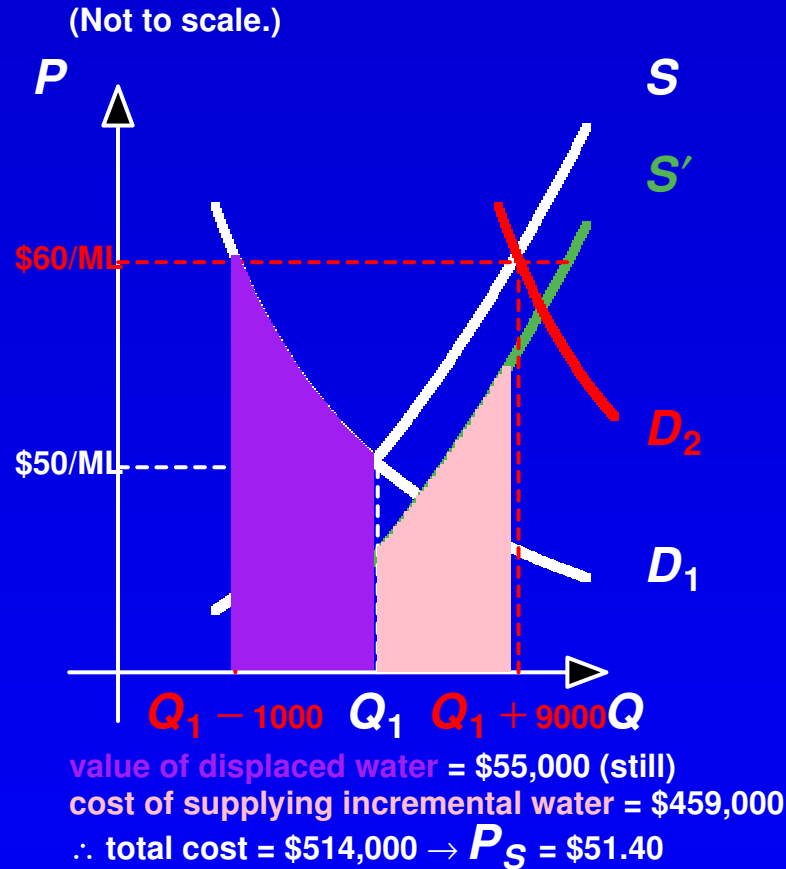

For a FA, cost =  $\$60 \times 10,000 = \$600,000$

For a CBA, cost =  $\$51.40 \times 10,000 = \$514,000$

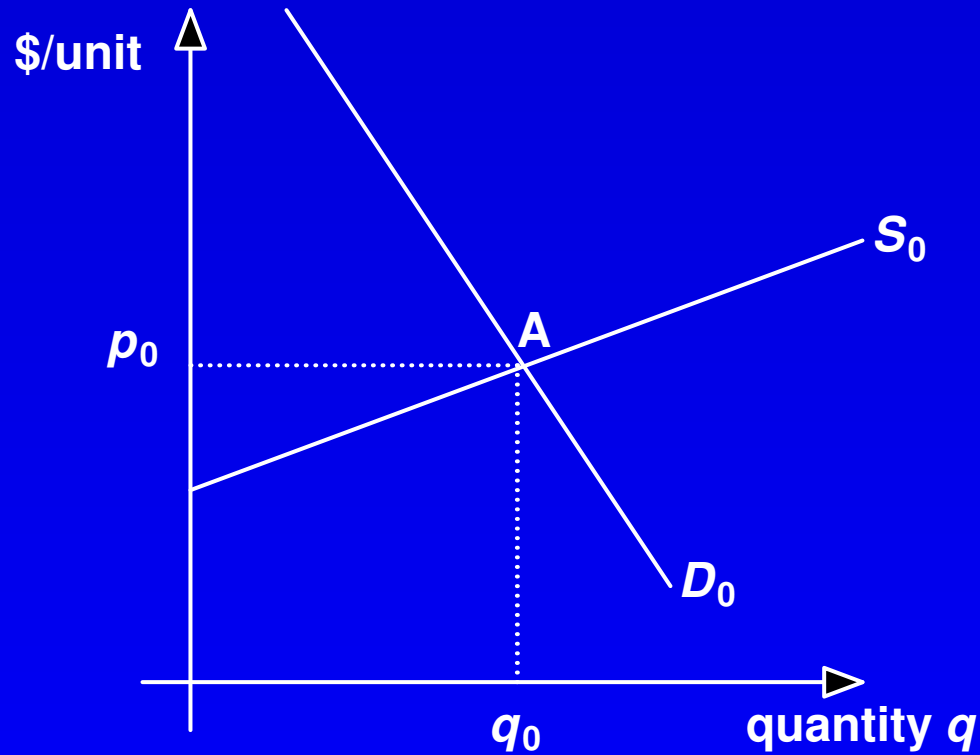
**Price Change & Tax (cont.)*****Elastic supply***



**Price Change & Tax (cont.)**

*Elastic supply*

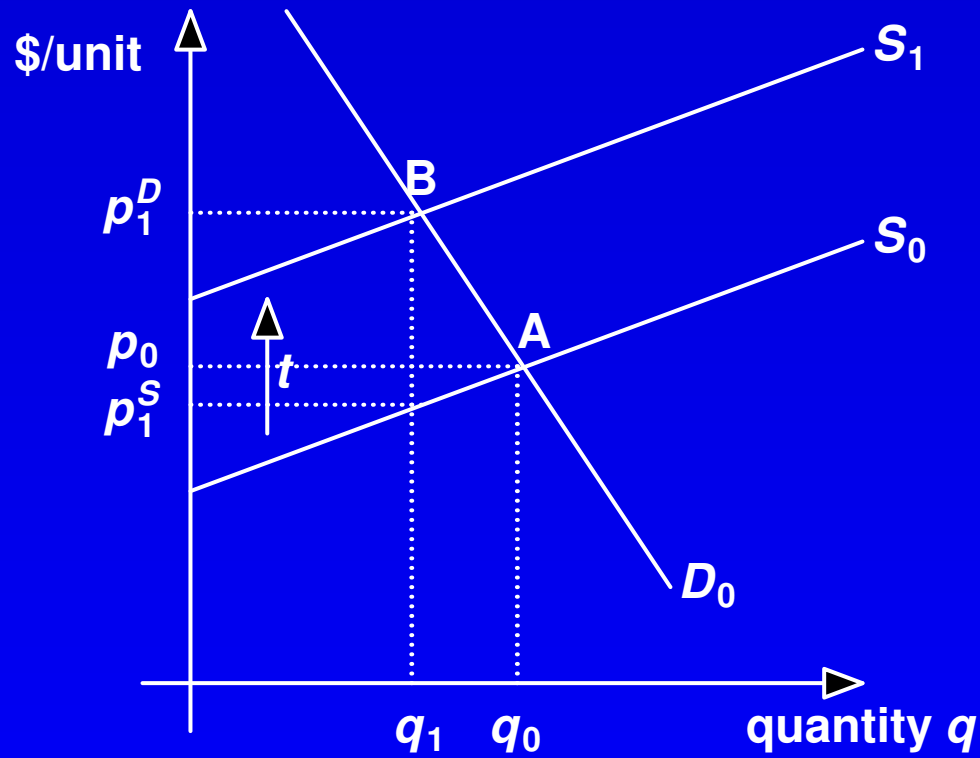

Figure 1

---

***Price Change & Tax (cont.)***

**In Figure 1 above:**

-

***Price Change & Tax (cont.)***

In Figure 1 above:

- $p_0, q_0$  is the initial price at A
-

***Price Change & Tax (cont.)***

In Figure 1 above:

- $p_0, q_0$  is the initial price at A
- A specific tax of  $p_1^D - p_1^S = t$  is imposed
-

## **Price Change & Tax (cont.)**

In Figure 1 above:

- $p_0, q_0$  is the initial price at A
- A specific tax of  $p_1^D - p_1^S = t$  is imposed
- This is perceived by consumers as a shift in supply from  $S_0$  to  $S_1$

∴

## **Price Change & Tax (cont.)**

In Figure 1 above:

- $p_0, q_0$  is the initial price at A
- A specific tax of  $p_1^D - p_1^S = t$  is imposed
- This is perceived by consumers as a shift in supply from  $S_0$  to  $S_1$
- ∴ buyers pay (tax-inclusive)  $p_1^D$  and producers receive (tax-exclusive)  $p_1^S$
-

## **Price Change & Tax (cont.)**

In Figure 1 above:

- $p_0, q_0$  is the initial price at A
- A specific tax of  $p_1^D - p_1^S = t$  is imposed
- This is perceived by consumers as a shift in supply from  $S_0$  to  $S_1$
- ∴ buyers pay (tax-inclusive)  $p_1^D$  and producers receive (tax-exclusive)  $p_1^S$
- The tax revenue is  $(p_1^D - p_1^S)q_1 = tq_1$
-

## **Price Change & Tax (cont.)**

In Figure 1 above:

- $p_0, q_0$  is the initial price at A
- A specific tax of  $p_1^D - p_1^S = t$  is imposed
- This is perceived by consumers as a shift in supply from  $S_0$  to  $S_1$
- ∴ buyers pay (tax-inclusive)  $p_1^D$  and producers receive (tax-exclusive)  $p_1^S$
- The tax revenue is  $(p_1^D - p_1^S)q_1 = tq_1$
- Consumption falls from  $q_0$  to  $q_1$  (by  $b$ )
-



## Price Change & Tax (cont.)

In Figure 1 above:

- $p_0, q_0$  is the initial price at A
- A specific tax of  $p_1^D - p_1^S = t$  is imposed
- This is perceived by consumers as a shift in supply from  $S_0$  to  $S_1$
- ∴ buyers pay (tax-inclusive)  $p_1^D$  and producers receive (tax-exclusive)  $p_1^S$
- The tax revenue is  $(p_1^D - p_1^S)q_1 = tq_1$
- Consumption falls from  $q_0$  to  $q_1$  (by  $b$ )
- The tax revenue is a **transfer** from consumers of the product to consumers in general (via tax receipts and government expenditure)

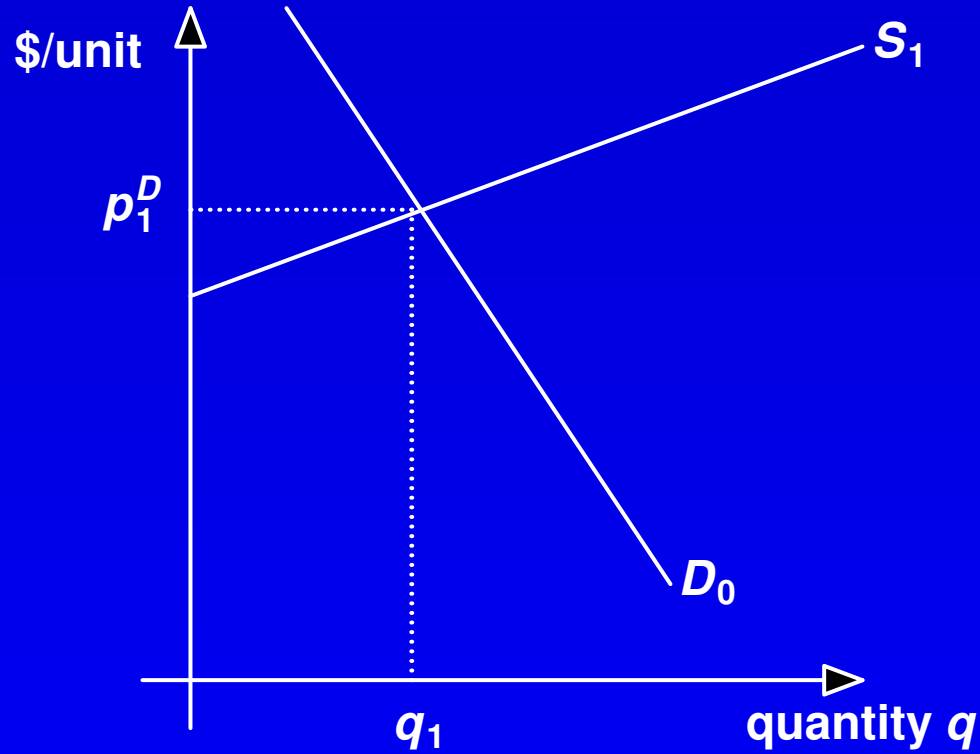
**Price Change & Tax (cont.)**

**Price Change & Tax (cont.)**

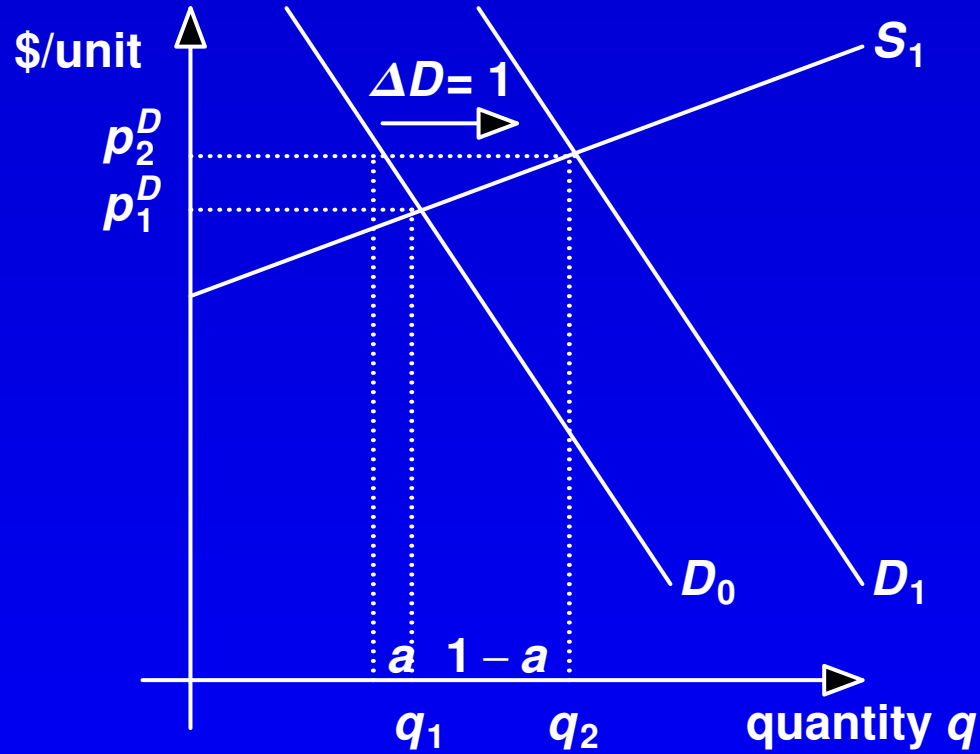

Figure 2

---

***Price Change & Tax (cont.)***

In Figure 2:

-

## ***Price Change & Tax (cont.)***

In Figure 2:

- $p_1$  is the initial tax-inclusive price =  $p_1^D$
-

## ***Price Change & Tax (cont.)***

In Figure 2:

- $p_1$  is the initial tax-inclusive price =  $p_1^D$
- because supply  $S_1$  includes the tax  $t$
-

## **Price Change & Tax (cont.)**

In Figure 2:

- $p_1$  is the initial tax-inclusive price =  $p_1^D$
- because supply  $S_1$  includes the tax  $t$
- The project to be evaluated shifts the demand for the input to the right from  $D_1$  to  $D_2$  (assume  $\Delta D = 1$ )

∴

## **Price Change & Tax (cont.)**

In Figure 2:

- $p_1$  is the initial tax-inclusive price =  $p_1^D$
- because supply  $S_1$  includes the tax  $t$
- The project to be evaluated shifts the demand for the input to the right from  $D_1$  to  $D_2$  (assume  $\Delta D = 1$ )
- ∴ the tax-inclusive price is forced up from  $p_1$  to  $p_2 = p_2^D$
-



## **Price Change & Tax (cont.)**

In Figure 2:

- $p_1$  is the initial tax-inclusive price =  $p_1^D$
- because supply  $S_1$  includes the tax  $t$
- The project to be evaluated shifts the demand for the input to the right from  $D_1$  to  $D_2$  (assume  $\Delta D = 1$ )
- ∴ the tax-inclusive price is forced up from  $p_1$  to  $p_2 = p_2^D$
- and production goes up in total by  $1 - a$
-

## **Price Change & Tax (cont.)**

In Figure 2:

- $p_1$  is the initial tax-inclusive price =  $p_1^D$
- because supply  $S_1$  includes the tax  $t$
- The project to be evaluated shifts the demand for the input to the right from  $D_1$  to  $D_2$  (assume  $\Delta D = 1$ )
- ∴ the tax-inclusive price is forced up from  $p_1$  to  $p_2 = p_2^D$
- and production goes up in total by  $1 - a$
- The price increase induces other uses of the good to release an amount  $a$  which is absorbed by the project
- ∴

## Price Change & Tax (cont.)

In Figure 2:

- $p_1$  is the initial tax-inclusive price =  $p_1^D$
- because supply  $S_1$  includes the tax  $t$
- The project to be evaluated shifts the demand for the input to the right from  $D_1$  to  $D_2$  (assume  $\Delta D = 1$ )
- ∴ the tax-inclusive price is forced up from  $p_1$  to  $p_2 = p_2^D$
- and production goes up in total by  $1 - a$
- The price increase induces other uses of the good to release an amount  $a$  which is absorbed by the project
- ∴ total usage of the input is  $a + 1 - a = 1$  in the project.
-

## Price Change & Tax (cont.)

In Figure 2:

- $p_1$  is the initial tax-inclusive price =  $p_1^D$
- because supply  $S_1$  includes the tax  $t$
- The project to be evaluated shifts the demand for the input to the right from  $D_1$  to  $D_2$  (assume  $\Delta D = 1$ )
- ∴ the tax-inclusive price is forced up from  $p_1$  to  $p_2 = p_2^D$
- and production goes up in total by  $1 - a$
- The price increase induces other uses of the good to release an amount  $a$  which is absorbed by the project
- ∴ total usage of the input is  $a + 1 - a = 1$  in the project.
- The expansion in output takes place at the tax-exclusive cost  $S_1 - t$  or  $p_2 - t$ .
- The gain to the taxpayer is simply a **transfer** ∴ ignore it.
-

## Price Change & Tax (cont.)

In Figure 2:

- $p_1$  is the initial tax-inclusive price =  $p_1^D$
- because supply  $S_1$  includes the tax  $t$
- The project to be evaluated shifts the demand for the input to the right from  $D_1$  to  $D_2$  (assume  $\Delta D = 1$ )
- ∴ the tax-inclusive price is forced up from  $p_1$  to  $p_2 = p_2^D$
- and production goes up in total by  $1 - a$
- The price increase induces other uses of the good to release an amount  $a$  which is absorbed by the project
- ∴ total usage of the input is  $a + 1 - a = 1$  in the project.
- The expansion in output takes place at the tax-exclusive cost  $S_1 - t$  or  $p_2 - t$ .
- The gain to the taxpayer is simply a **transfer** ∴ ignore it.
- Existing consumers value the reduction in  $a$  at the tax-inclusive price  $p_2^D$  that they pay
- ∴

## Price Change & Tax (cont.)

In Figure 2:

- $p_1$  is the initial tax-inclusive price =  $p_1^D$
- because supply  $S_1$  includes the tax  $t$
- The project to be evaluated shifts the demand for the input to the right from  $D_1$  to  $D_2$  (assume  $\Delta D = 1$ )
- ∴ the tax-inclusive price is forced up from  $p_1$  to  $p_2 = p_2^D$
- and production goes up in total by  $1 - a$
- The price increase induces other uses of the good to release an amount  $a$  which is absorbed by the project
- ∴ total usage of the input is  $a + 1 - a = 1$  in the project.
- The expansion in output takes place at the tax-exclusive cost  $S_1 - t$  or  $p_2 - t$ .
- The gain to the taxpayer is simply a **transfer** ∴ ignore it.
- Existing consumers value the reduction in  $a$  at the tax-inclusive price  $p_2^D$  that they pay
- ∴ unit social cost =  $a(\text{gross-of-tax price}) + (1 - a)(\text{net-of-tax price})$   

$$= a p_2^D + (1 - a)(p_2^D - t) = \text{shadow price}$$

Hence shadow price = a weighted average of the tax-inclusive and tax-exclusive prices,  $p_2$  and  $p_2 - t$ , respectively.

***Price Change & Tax (cont.)***

**How do we calculate the weights  $a$  and  $1 - a$ ?:**

$$\eta_D =$$

***Price Change & Tax (cont.)***

**How do we calculate the weights  $a$  and  $1 - a$ ?:**

$\eta_D =$  initial price elasticity of demand at  $p_1$

$\eta_D =$



## ***Price Change & Tax (cont.)***

**How do we calculate the weights  $a$  and  $1 - a$ ?:**

$\eta_D =$  initial price elasticity of demand at  $p_1$

$$\eta_D = -\frac{a/q_1}{(p_2 - p_1)/p_1} \text{ (using initial-point convention)}$$

## **Price Change & Tax (cont.)**

**How do we calculate the weights  $a$  and  $1 - a$ ?:**

$\eta_D =$  initial price elasticity of demand at  $p_1$

$$\eta_D = - \frac{a/q_1}{(p_2 - p_1)/p_1} \text{ (using initial-point convention)}$$

**= % change in quantity  $\div$  % change in price**

## **Price Change & Tax (cont.)**

**How do we calculate the weights  $a$  and  $1 - a$ ?:**

$\eta_D =$  initial price elasticity of demand at  $p_1$

$$\eta_D = - \frac{a/q_1}{(p_2 - p_1)/p_1} \text{ (using initial-point convention)}$$

= % change in quantity  $\div$  % change in price

**Similarly:**

$\kappa_S =$

## Price Change & Tax (cont.)

How do we calculate the weights  $a$  and  $1 - a$ ?:

$\eta_D$  = initial price elasticity of demand at  $p_1$

$$\eta_D = - \frac{a/q_1}{(p_2 - p_1)/p_1} \text{ (using initial-point convention)}$$

= % change in quantity  $\div$  % change in price

Similarly:

$$\kappa_S = \text{supply elasticity} = \frac{(1 - a)/q_1}{(p_2 - p_1)/p_1}$$

## Price Change & Tax (cont.)

How do we calculate the weights  $a$  and  $1 - a$ ?:

$\eta_D$  = initial price elasticity of demand at  $p_1$

$$\eta_D = - \frac{a/q_1}{(p_2 - p_1)/p_1} \text{ (using initial-point convention)}$$

= % change in quantity  $\div$  % change in price

Similarly:

$$\kappa_S = \text{supply elasticity} = \frac{(1 - a)/q_1}{(p_2 - p_1)/p_1}$$

$$\text{Hence } \frac{\eta_D}{\kappa_S} = - \frac{a}{1 - a}$$

$$\text{and } \therefore a = - \frac{\eta_D}{\kappa_S - \eta_D}$$

and Shadow Price =  $ap_2 + (1 - a)(p_2 - t)$ :

•

## Price Change & Tax (cont.)

How do we calculate the weights  $a$  and  $1 - a$ ?:

$\eta_D$  = initial price elasticity of demand at  $p_1$

$$\eta_D = - \frac{a/q_1}{(p_2 - p_1)/p_1} \quad (\text{using initial-point convention})$$

= % change in quantity  $\div$  % change in price

Similarly:

$$\kappa_S = \text{supply elasticity} = \frac{(1 - a)/q_1}{(p_2 - p_1)/p_1}$$

$$\text{Hence } \frac{\eta_D}{\kappa_S} = - \frac{a}{1 - a}$$

$$\text{and } \therefore a = - \frac{\eta_D}{\kappa_S - \eta_D}$$

and Shadow Price =  $ap_2 + (1 - a)(p_2 - t)$ :

- for an increased demand for the input
-

## Price Change & Tax (cont.)

How do we calculate the weights  $a$  and  $1 - a$ ?:

$\eta_D$  = initial price elasticity of demand at  $p_1$

$$\eta_D = - \frac{a/q_1}{(p_2 - p_1)/p_1} \quad (\text{using initial-point convention})$$

= % change in quantity  $\div$  % change in price

Similarly:

$$\kappa_S = \text{supply elasticity} = \frac{(1 - a)/q_1}{(p_2 - p_1)/p_1}$$

$$\text{Hence } \frac{\eta_D}{\kappa_S} = - \frac{a}{1 - a}$$

$$\text{and } \therefore a = - \frac{\eta_D}{\kappa_S - \eta_D}$$

and Shadow Price =  $ap_2 + (1 - a)(p_2 - t)$ :

- for an increased demand for the input
- also for an increase in supply of the good if the project results in more of the good

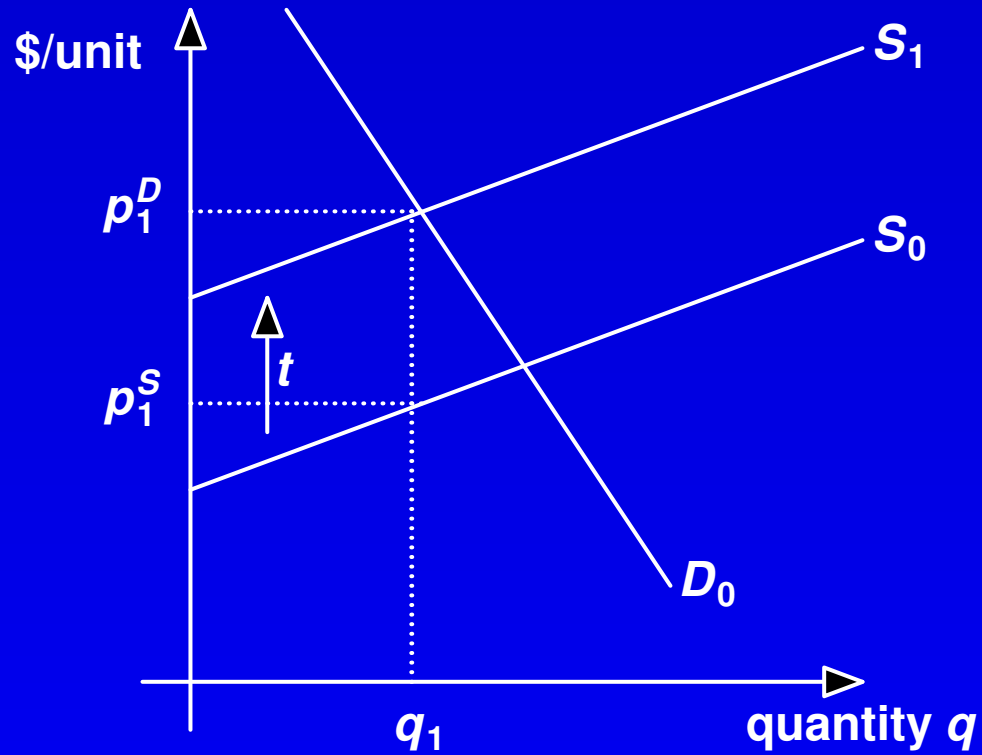
**Price Change & Tax (cont.) — Figure 3**



**Price Change & Tax (cont.) — Figure 3**

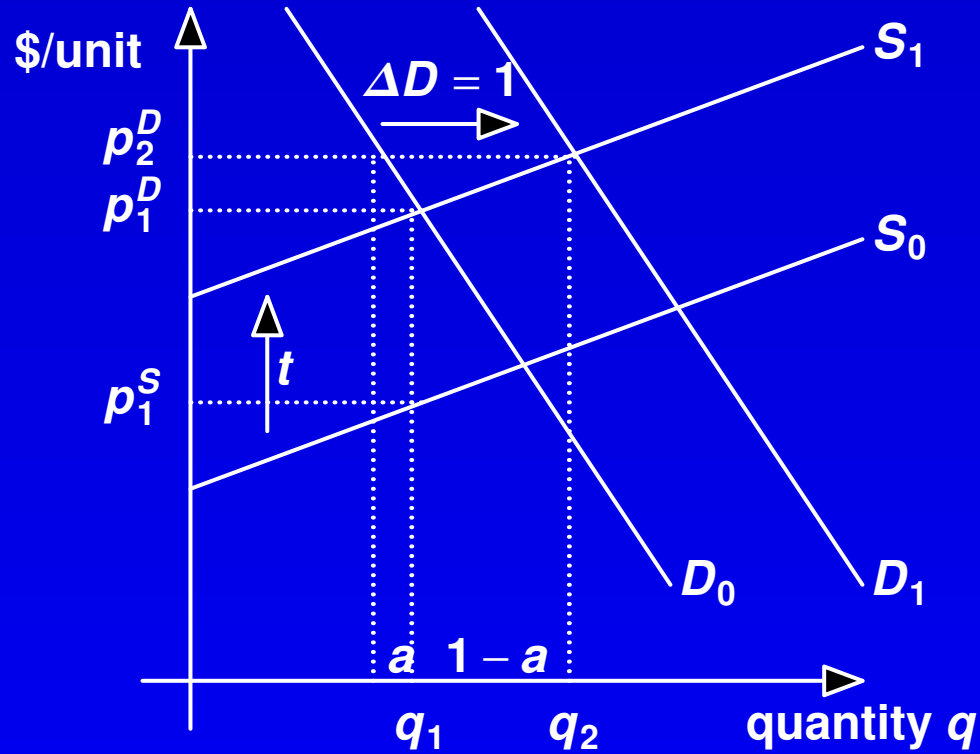

•

**Price Change & Tax (cont.) — Figure 3**

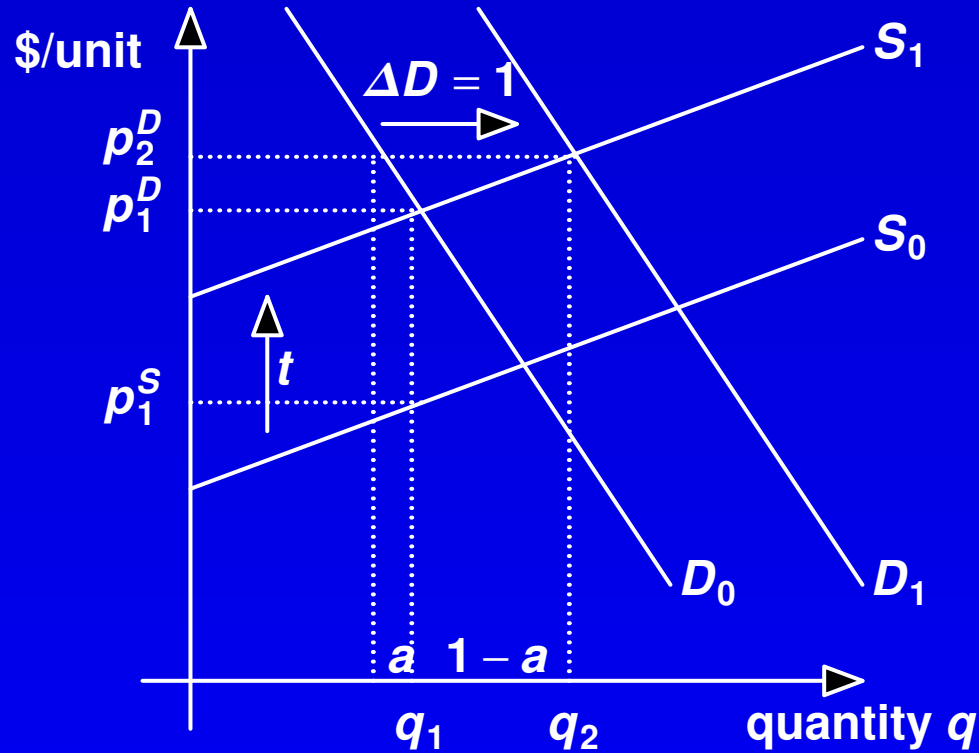

- Valuation of the increased supply  $1 - a$  depends on  $S_0$  (tax-exclusive)

•

**Price Change & Tax (cont.) — Figure 3**

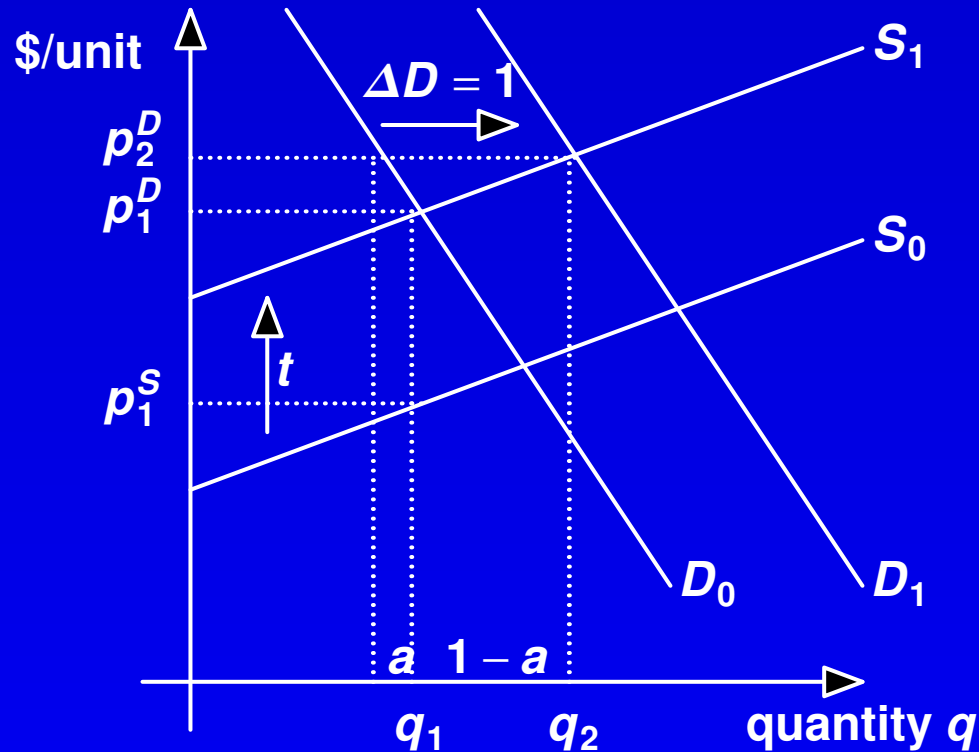

- Valuation of the increased supply  $1 - a$  depends on  $S_0$  (tax-exclusive)
- Valuation of the demand shifted to the project  $a$  depends on the shaded area under  $D_1$
-

**Price Change & Tax (cont.) — Figure 3**

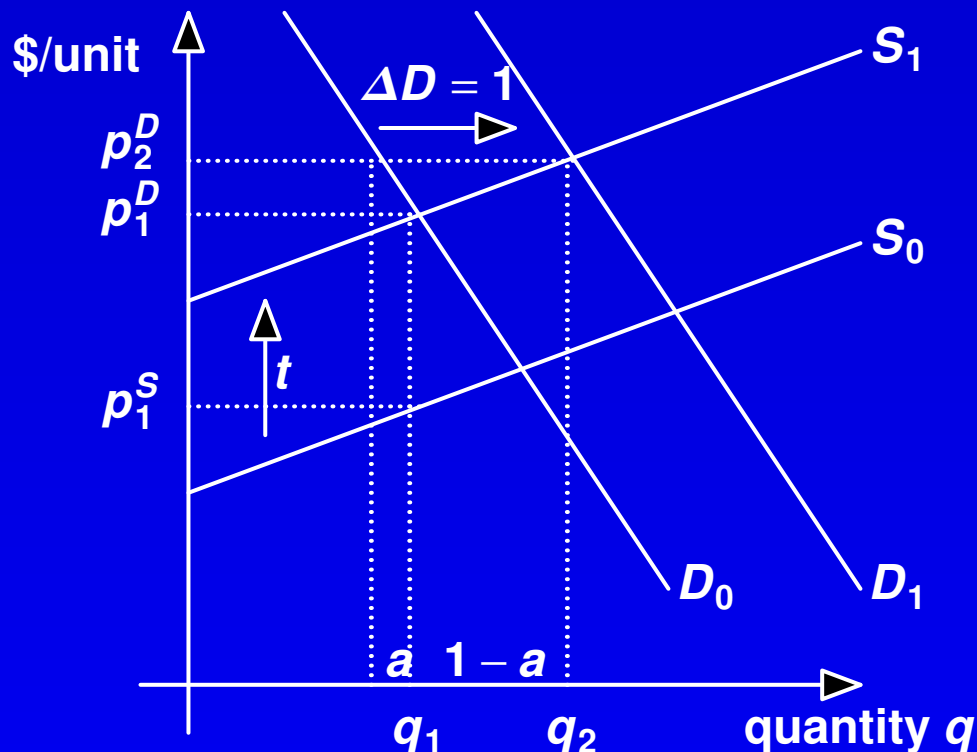

- Valuation of the increased supply  $1 - a$  depends on  $S_0$  (tax-exclusive)
- Valuation of the demand shifted to the project  $a$  depends on the shaded area under  $D_1$
- Figure 3 adds the tax-exclusive supply curve  $S_0$  to Figure 2
-

**Price Change & Tax (cont.) — Figure 3**

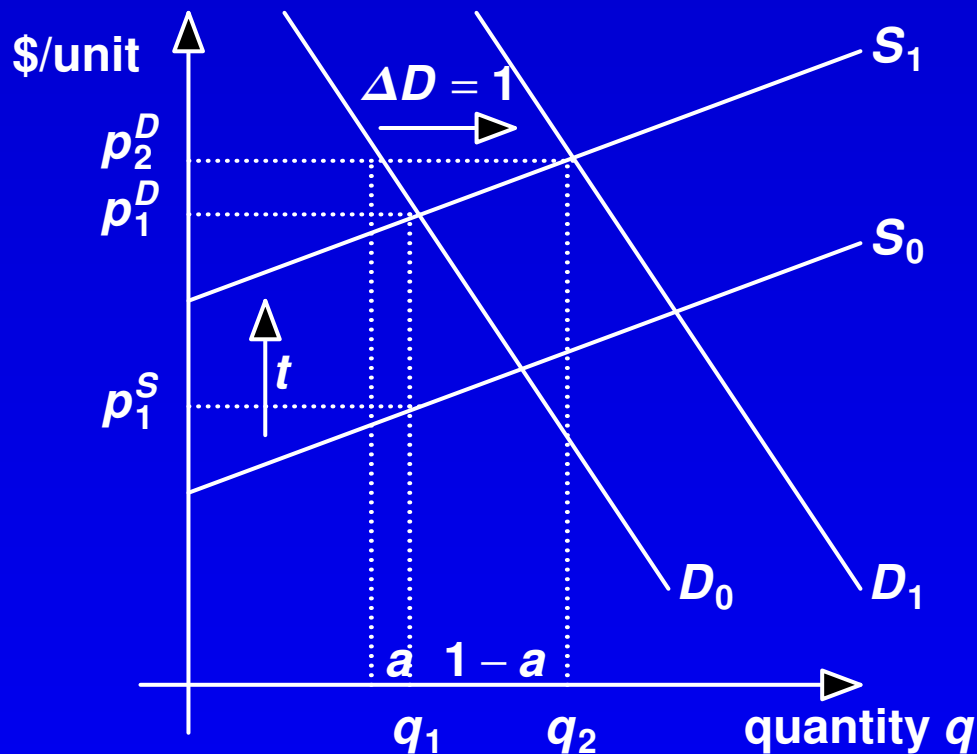

- Valuation of the increased supply  $1 - a$  depends on  $S_0$  (tax-exclusive)
- Valuation of the demand shifted to the project  $a$  depends on the shaded area under  $D_1$
- Figure 3 adds the tax-exclusive supply curve  $S_0$  to Figure 2
- So  $\Delta D \times p_S =$  the sum of the two areas

---

**1.4 Example 4: Shadow pricing of labour** [C&B pp. 96–98; FP Ch. 6.4.1, Ch. 10; DoF 3.9]

-

**1.4 Example 4: Shadow pricing of labour** [C&B pp. 96–98; FP Ch. 6.4.1, Ch. 10; DoF 3.9]

- In a competitive labour market the shadow price of labour is simply the market wage:

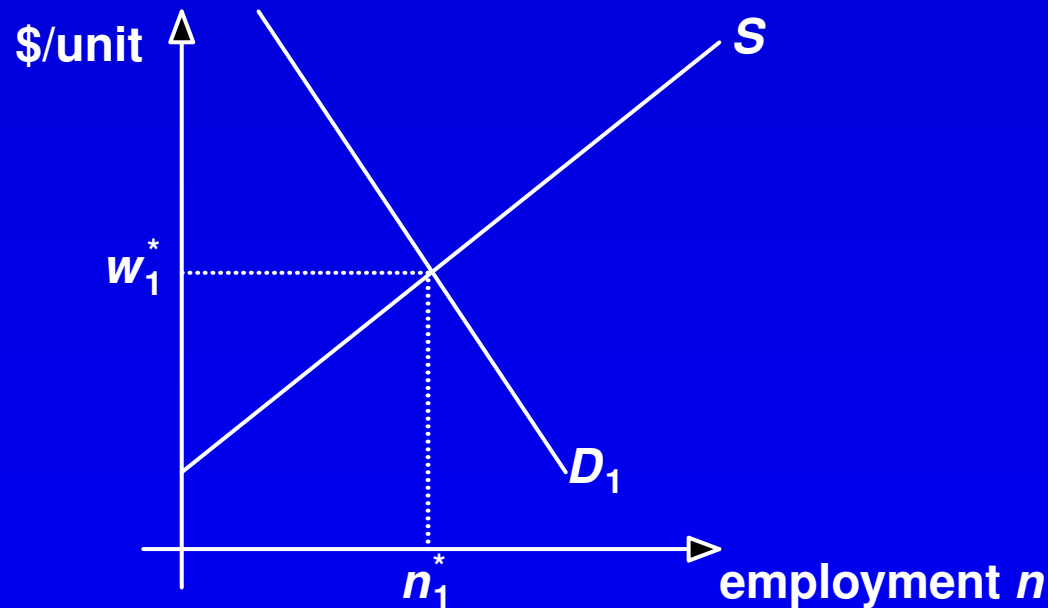

**1.4 Example 4: Shadow pricing of labour** [C&B pp. 96–98; FP Ch. 6.4.1, Ch. 10; DoF 3.9]

- In a competitive labour market the shadow price of labour is simply the market wage:

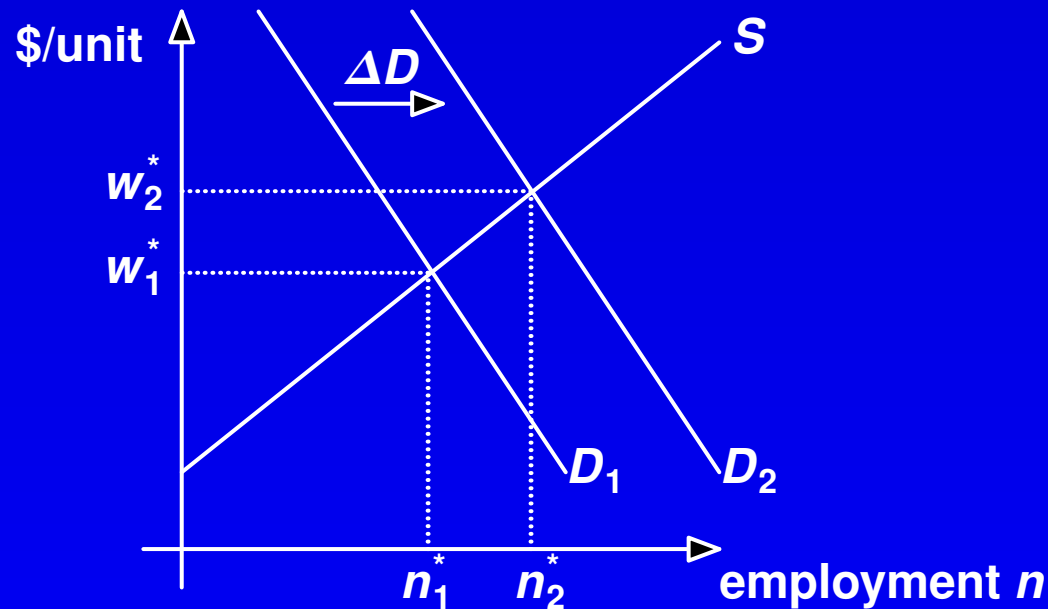

•



**1.4 Example 4: Shadow pricing of labour** [C&B pp. 96–98; FP Ch. 6.4.1, Ch. 10; DoF 3.9]

- In a competitive labour market the shadow price of labour is simply the market wage:

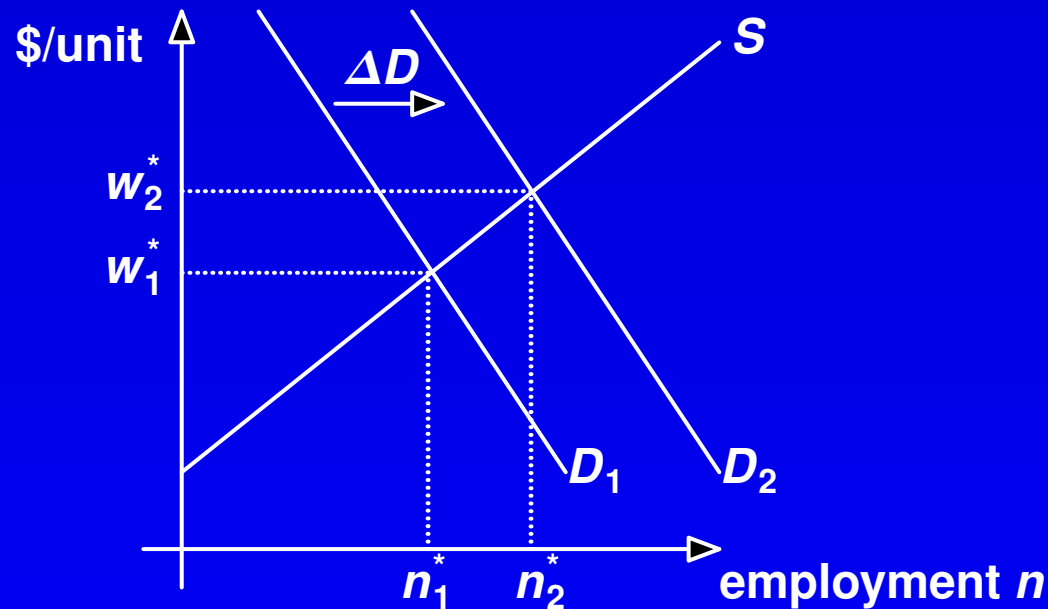

- But the project shifts the demand for labour from  $D_1$  to  $D_2$

-

### 1.4 Example 4: Shadow pricing of labour [C&B pp. 96–98; FP Ch. 6.4.1, Ch. 10; DoF 3.9]

- In a competitive labour market the shadow price of labour is simply the market wage:

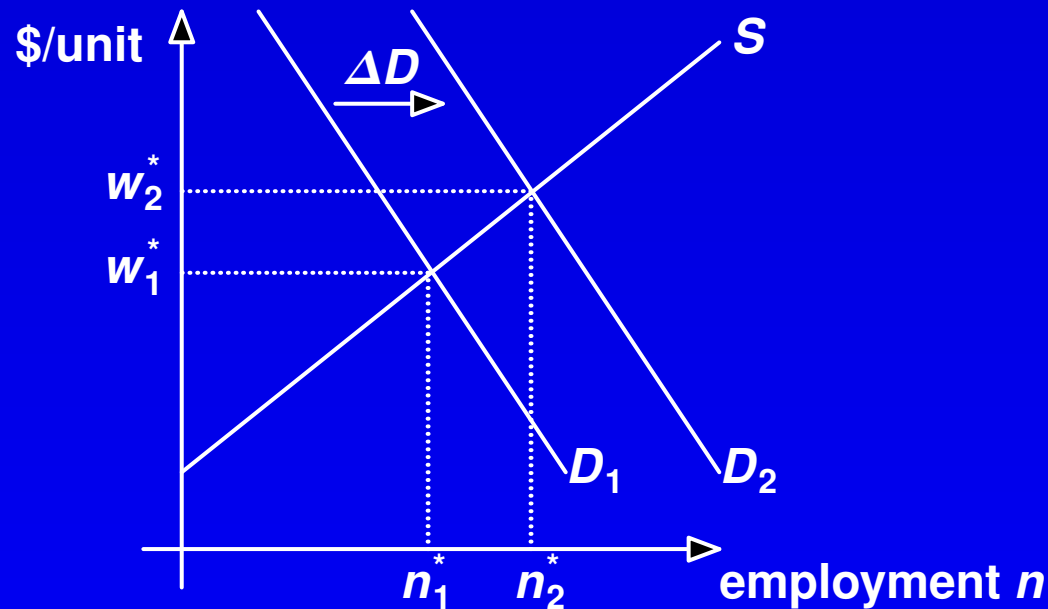

- But the project shifts the demand for labour from  $D_1$  to  $D_2$
- more jobs are “created” ( $n_2^* - n_1^*$ )
-

**1.4 Example 4: Shadow pricing of labour** [C&B pp. 96–98; FP Ch. 6.4.1, Ch. 10; DoF 3.9]

- In a competitive labour market the shadow price of labour is simply the market wage:

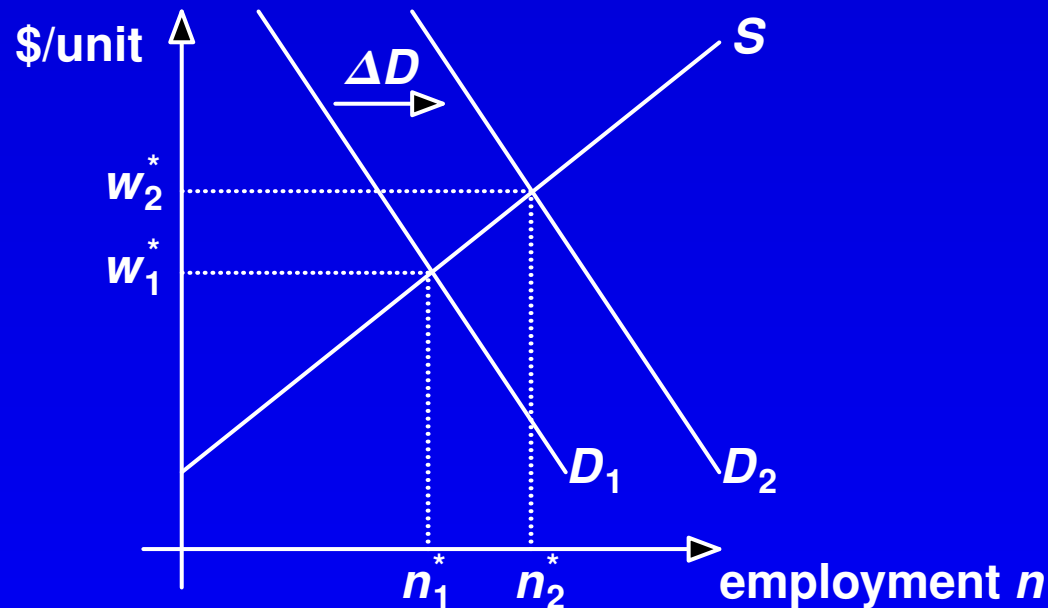

- But the project shifts the demand for labour from  $D_1$  to  $D_2$
- more jobs are “created” ( $n_2^* - n_1^*$ )
- workers move from lower-paid to higher-paid jobs
-

### 1.4 Example 4: Shadow pricing of labour [C&B pp. 96–98; FP Ch. 6.4.1, Ch. 10; DoF 3.9]

- In a competitive labour market the shadow price of labour is simply the market wage:

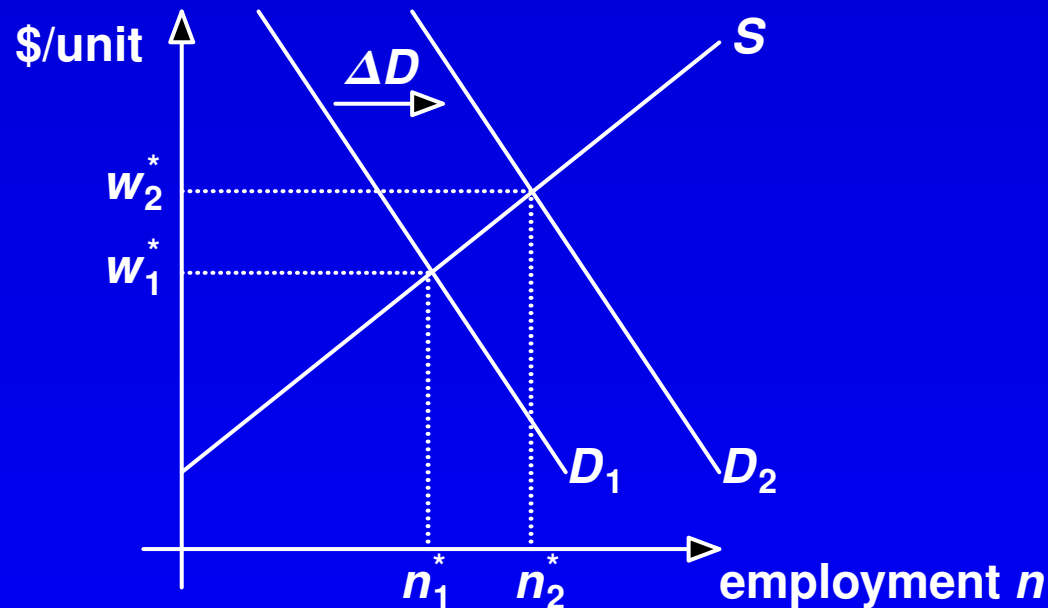

- But the project shifts the demand for labour from  $D_1$  to  $D_2$
- more jobs are “created” ( $n_2^* - n_1^*$ )
- workers move from lower-paid to higher-paid jobs
- and there is no “involuntary” unemployment

**Labour (cont.)** — Suppose there is a *minimum wage*  $\bar{w}$  for labour set by the IRT. Then the employment level  $n_1$  will be less than the competitive level,  $n_1^*$ .

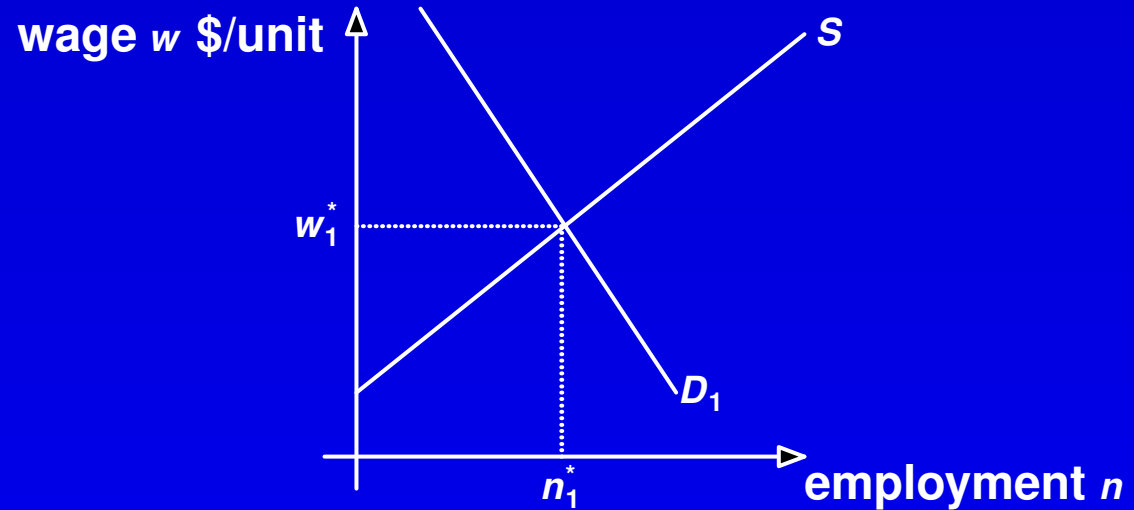

**Labour (cont.)** — Suppose there is a *minimum wage*  $\bar{w}$  for labour set by the IRT. Then the employment level  $n_1$  will be less than the competitive level,  $n_1^*$ .

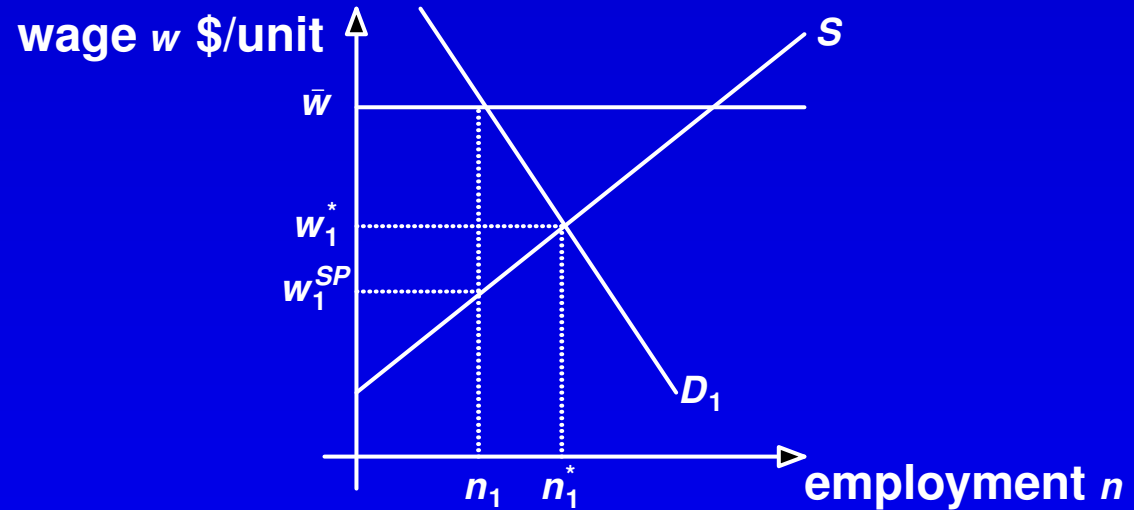

**Labour (cont.)** — Suppose there is a *minimum wage*  $\bar{w}$  for labour set by the IRT. Then the employment level  $n_1$  will be less than the competitive level,  $n_1^*$ .

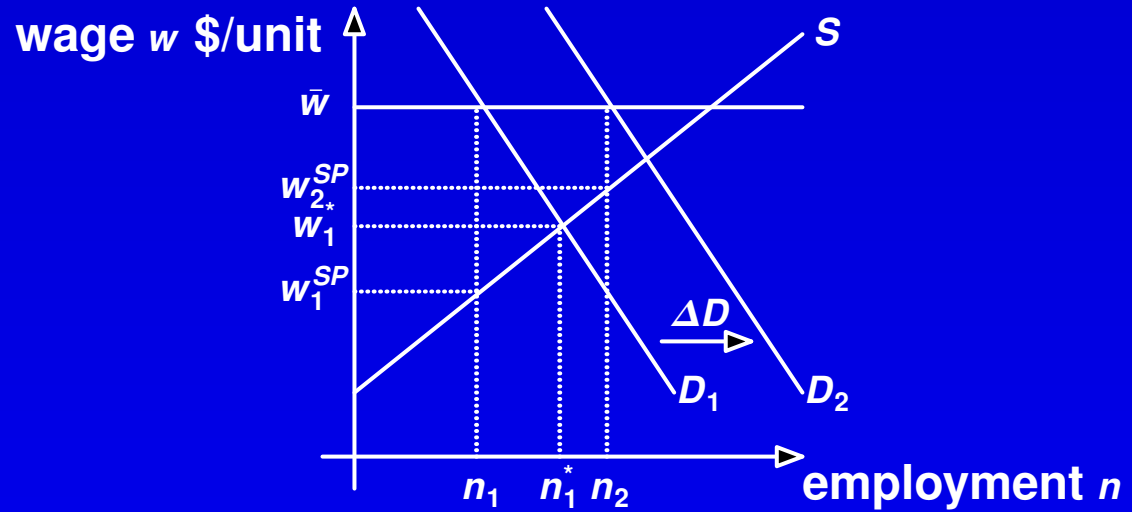

•

**Labour (cont.)** — Suppose there is a *minimum wage*  $\bar{w}$  for labour set by the IRT. Then the employment level  $n_1$  will be less than the competitive level,  $n_1^*$ .

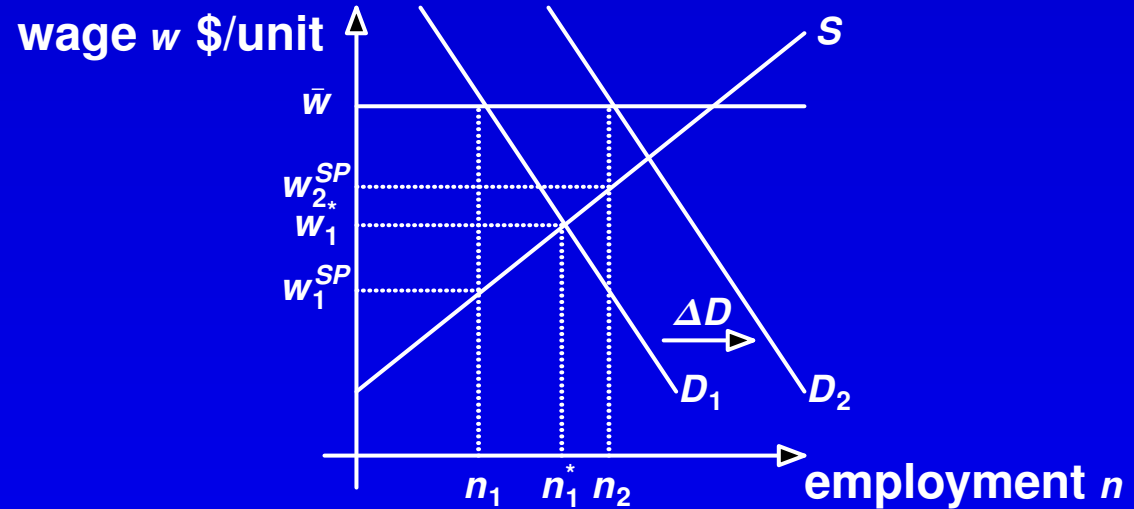

- The projects shifts out demand for labour from  $D_1$  to  $D_2$
-



**Labour (cont.)** — Suppose there is a *minimum wage*  $\bar{w}$  for labour set by the IRT. Then the employment level  $n_1$  will be less than the competitive level,  $n_1^*$ .

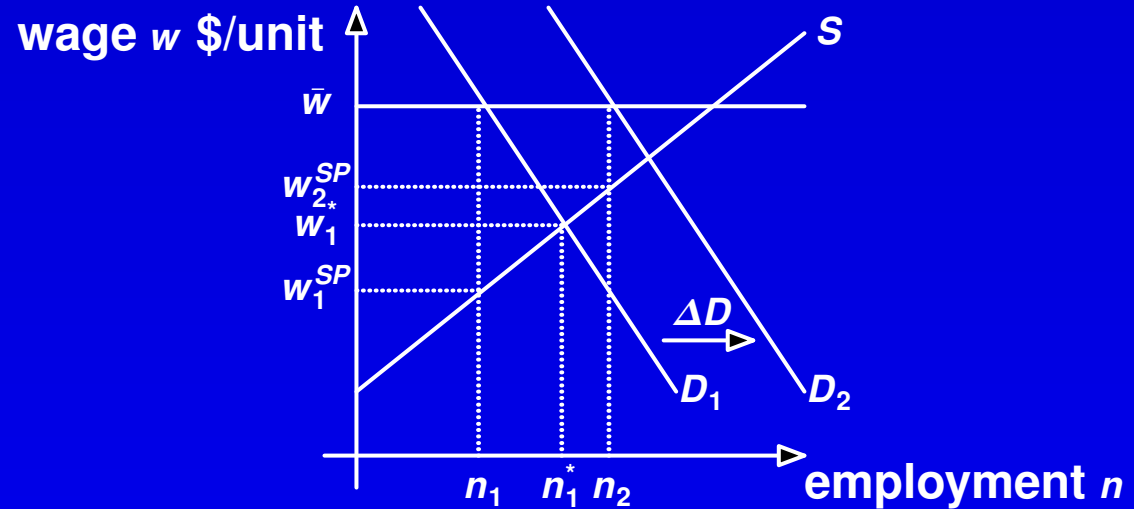

- The projects shifts out demand for labour from  $D_1$  to  $D_2$
- If the additional workers who receive jobs value leisure at  $w_1^{SP}$ , then  $w_1^{SP}$  is their shadow wage
-

**Labour (cont.)** — Suppose there is a *minimum wage*  $\bar{w}$  for labour set by the IRT. Then the employment level  $n_1$  will be less than the competitive level,  $n_1^*$ .

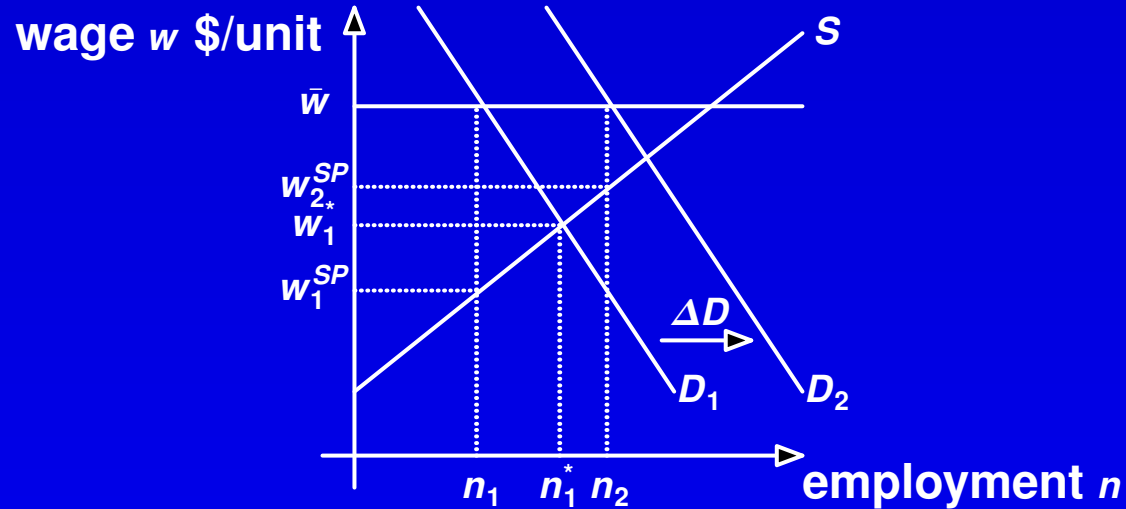

- The projects shifts out demand for labour from  $D_1$  to  $D_2$
- If the additional workers who receive jobs value leisure at  $w_1^{SP}$ , then  $w_1^{SP}$  is their shadow wage
- New employed workers may have a higher value of leisure  $w_2^{SP}$  than  $w_1^{SP}$

∴

**Labour (cont.)** — Suppose there is a *minimum wage*  $\bar{w}$  for labour set by the IRT. Then the employment level  $n_1$  will be less than the competitive level,  $n_1^*$ .

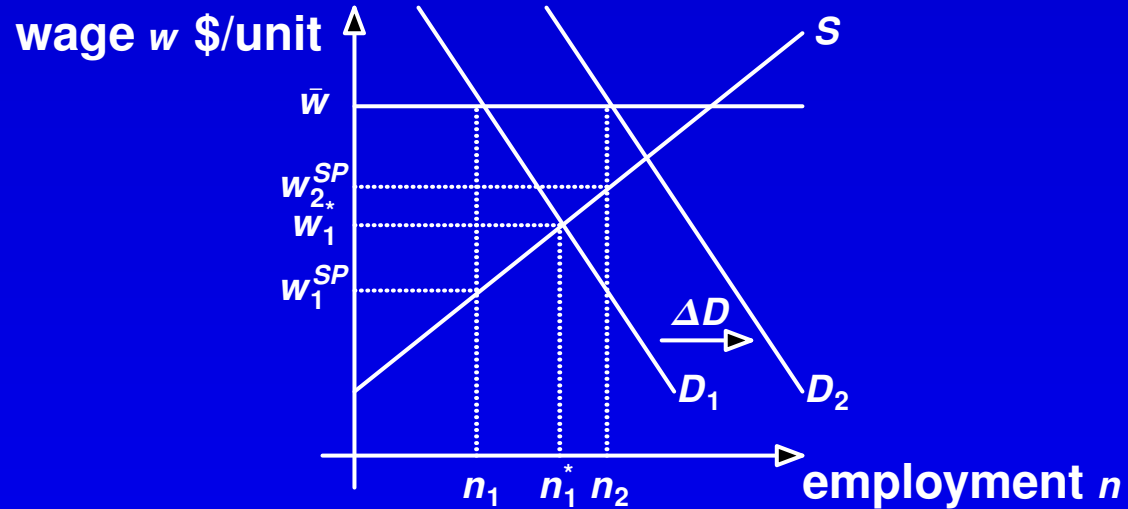

- The projects shifts out demand for labour from  $D_1$  to  $D_2$
  - If the additional workers who receive jobs value leisure at  $w_1^{SP}$ , then  $w_1^{SP}$  is their shadow wage
  - New employed workers may have a higher value of leisure  $w_2^{SP}$  than  $w_1^{SP}$
- ∴ this higher average value  $w_2^{SP}$  should be used for them

•

**Labour (cont.)** — Suppose there is a *minimum wage*  $\bar{w}$  for labour set by the IRT. Then the employment level  $n_1$  will be less than the competitive level,  $n_1^*$ .

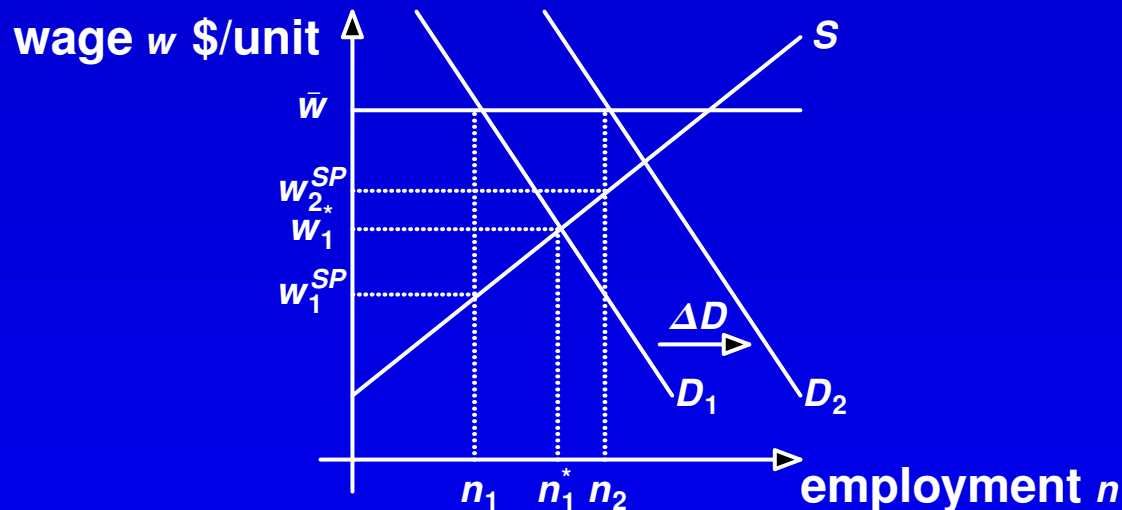

- The projects shifts out demand for labour from  $D_1$  to  $D_2$
- If the additional workers who receive jobs value leisure at  $w_1^{SP}$ , then  $w_1^{SP}$  is their shadow wage
- New employed workers may have a higher value of leisure  $w_2^{SP}$  than  $w_1^{SP}$
- ∴ this higher average value  $w_2^{SP}$  should be used for them
- The average social cost (shadow price) is lower than the market price  $\bar{w}$

•

**Labour (cont.)** — Suppose there is a *minimum wage*  $\bar{w}$  for labour set by the IRT. Then the employment level  $n_1$  will be less than the competitive level,  $n_1^*$ .

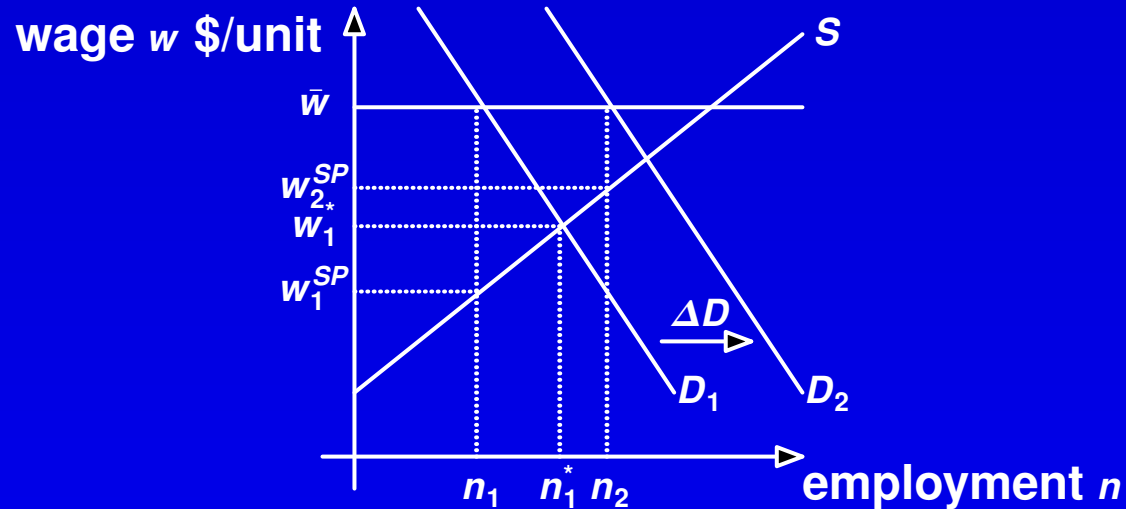

- The projects shifts out demand for labour from  $D_1$  to  $D_2$
- If the additional workers who receive jobs value leisure at  $w_1^{SP}$ , then  $w_1^{SP}$  is their shadow wage
- New employed workers may have a higher value of leisure  $w_2^{SP}$  than  $w_1^{SP}$
- ∴ this higher average value  $w_2^{SP}$  should be used for them
- The average social cost (shadow price) is lower than the market price  $\bar{w}$
- Why? Because there is *unemployment* at minimum wage  $\bar{w}$ .

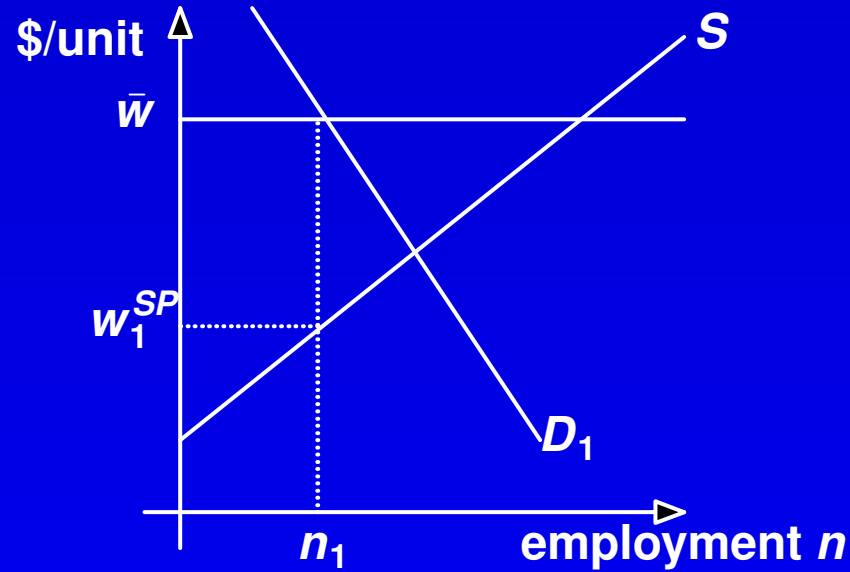
**Labour (cont.)**

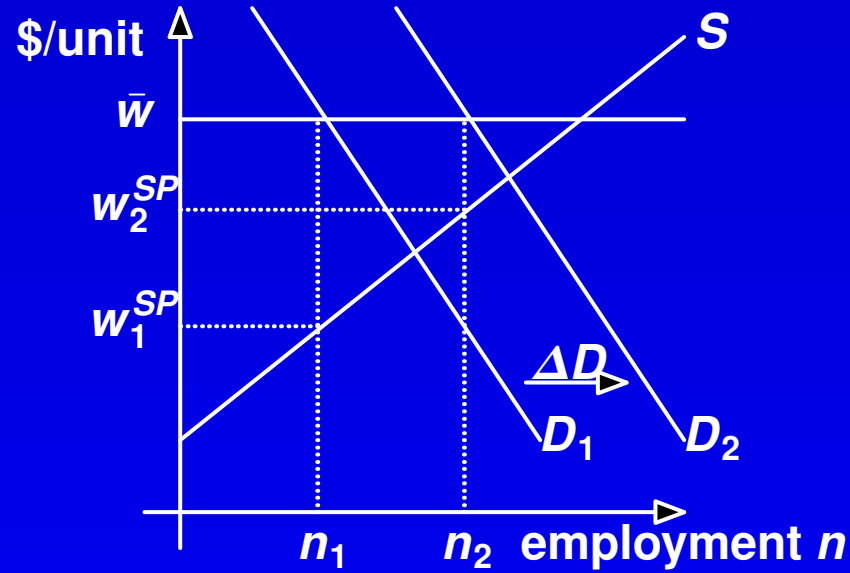
**Labour (cont.)**

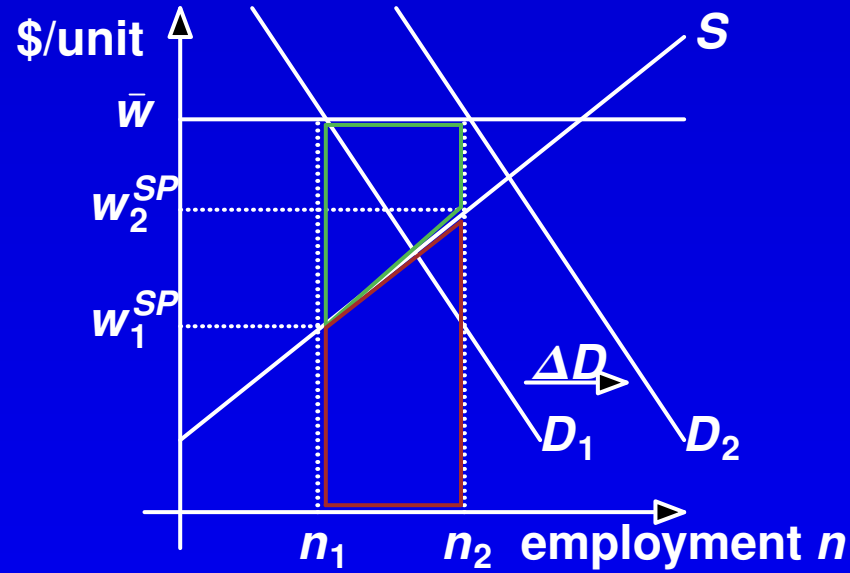
**Labour (cont.)**

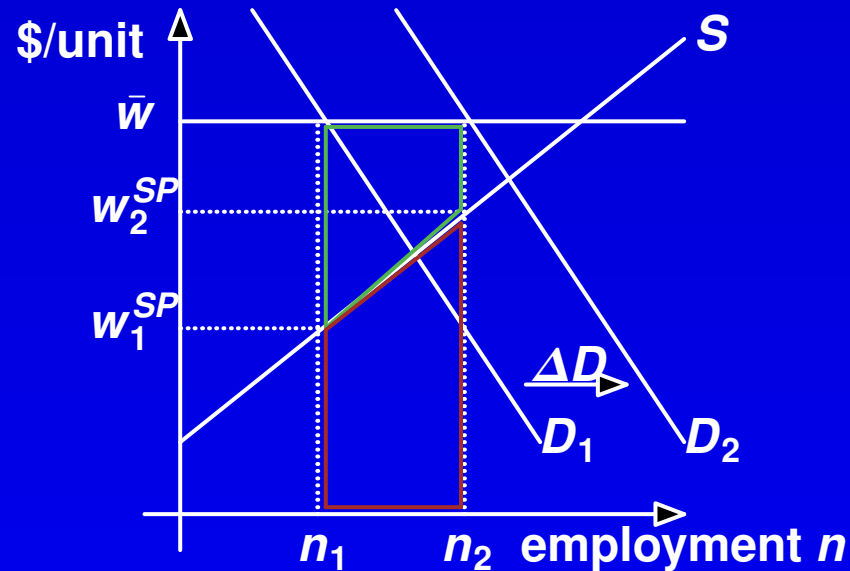

**Labour (cont.)**

- The change in the wage bill =  $\bar{w} \times (n_2 - n_1)$ ; in F.A. it was the “rectangle” (brown + green).

-

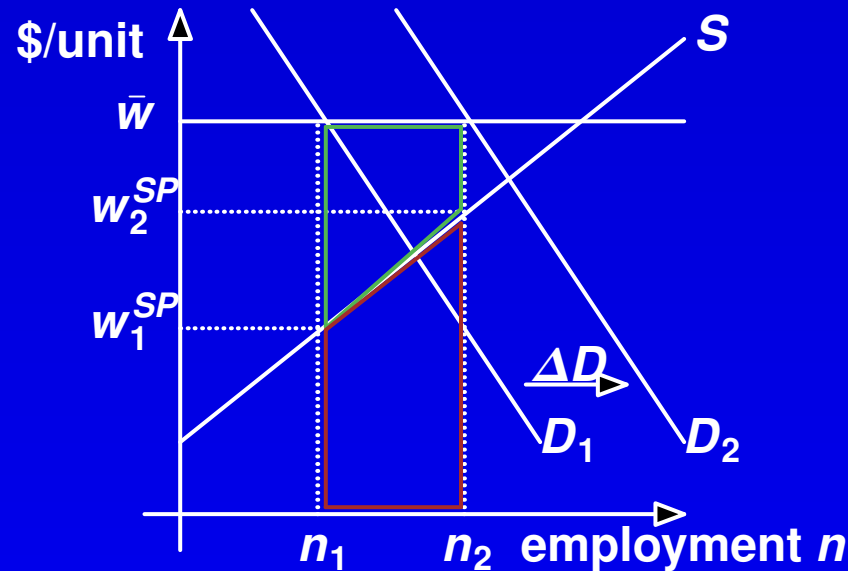
**Labour (cont.)**

- The change in the wage bill =  $\bar{w} \times (n_2 - n_1)$ ; in F.A. it was the “rectangle” (brown + green).
- The change in the social cost =  $\frac{W_1^{SP} + W_2^{SP}}{2} (n_2 - n_1)$ : brown area
-

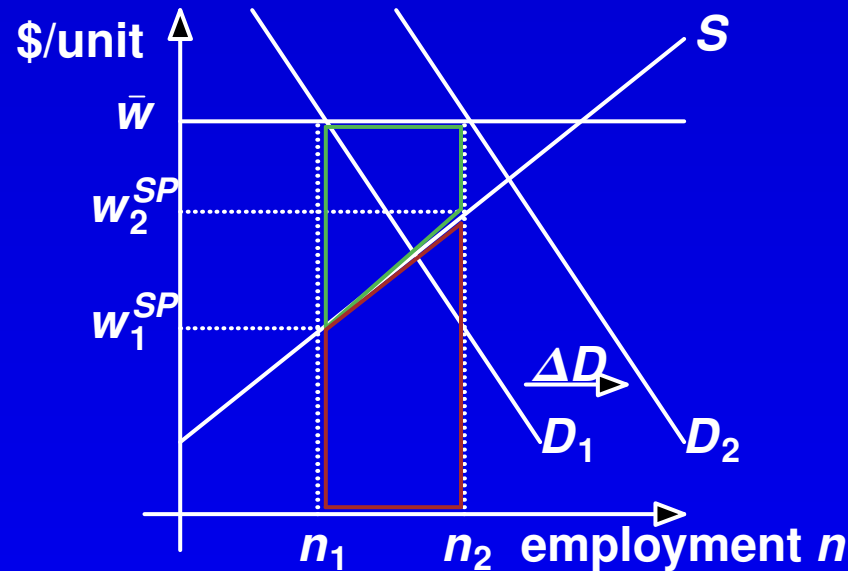
**Labour (cont.)**

- The change in the wage bill =  $\bar{w} \times (n_2 - n_1)$ ; in F.A. it was the “rectangle” (brown + green).
- The change in the social cost =  $\frac{w_1^{SP} + w_2^{SP}}{2} (n_2 - n_1)$ : brown area
- The opportunity cost of getting a job is less than  $\bar{w}$ , which is reflected in the supply curve.  $w^{SP} = \frac{1}{2} (w_1^{SP} + w_2^{SP})$

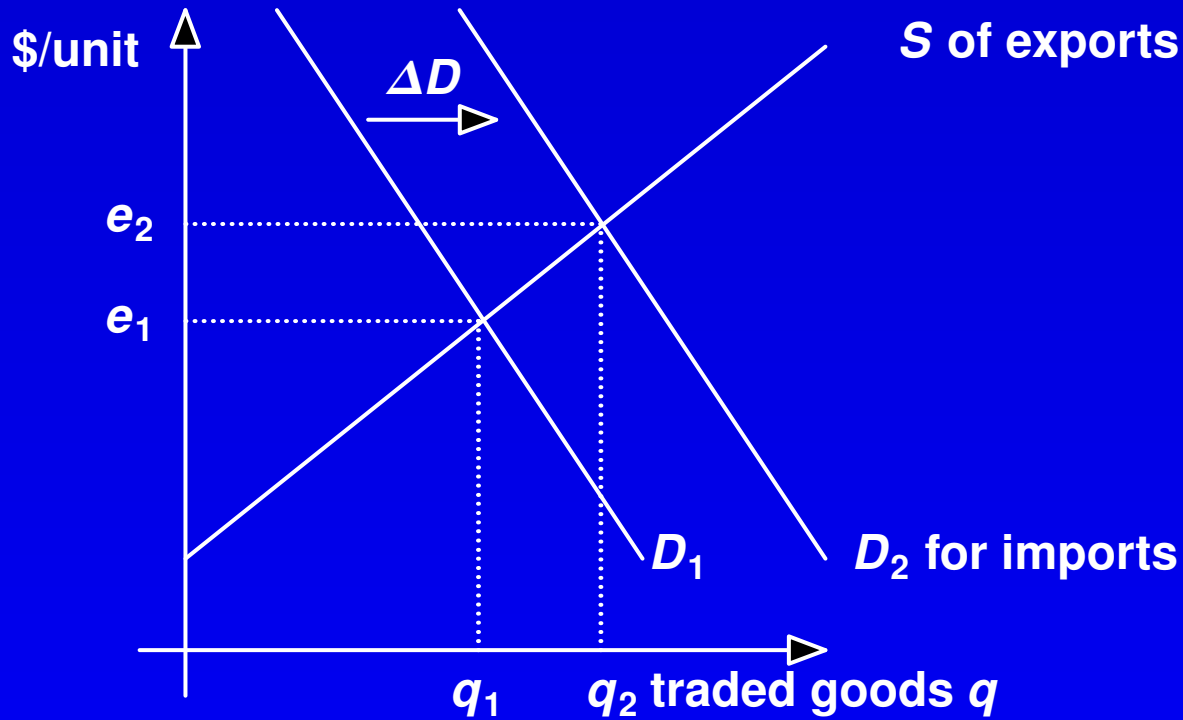
**1.5 Example 5: Foreign exchange** [C&B Ch. 8; FP Ch. 9.2; DoF 3.8]

---

## ***Foreign Exchange (cont.)***

**In the figure:**

-

---

## ***Foreign Exchange (cont.)***

**In the figure:**

- **the vertical axis shows the real price of traded goods = the inverse of the exchange rate.**
-

## **Foreign Exchange (cont.)**

In the figure:

- the vertical axis shows the real price of traded goods = the inverse of the exchange rate.
- the supply and demand for foreign currency is initially in balance at  $q_1, e_1$ .
-

## **Foreign Exchange (cont.)**

In the figure:

- the vertical axis shows the real price of traded goods = the inverse of the exchange rate.
- the supply and demand for foreign currency is initially in balance at  $q_1, e_1$ .
- if the demand for imports by Australians goes up by  $\Delta D$ , the real price of traded goods will cost more
-



## **Foreign Exchange (cont.)**

In the figure:

- the vertical axis shows the real price of traded goods = the inverse of the exchange rate.
- the supply and demand for foreign currency is initially in balance at  $q_1, e_1$ .
- if the demand for imports by Australians goes up by  $\Delta D$ , the real price of traded goods will cost more
- the \$A will devalue in terms of foreign currency as the real price of imports rises (and  $e$  rises)
-

## **Foreign Exchange (cont.)**

In the figure:

- the vertical axis shows the real price of traded goods = the inverse of the exchange rate.
- the supply and demand for foreign currency is initially in balance at  $q_1, e_1$ .
- if the demand for imports by Australians goes up by  $\Delta D$ , the real price of traded goods will cost more
- the \$A will devalue in terms of foreign currency as the real price of imports rises (and  $e$  rises)
- Australian exporters will gain more revenue in \$A terms, to encourage additional exports

∴

## **Foreign Exchange (cont.)**

In the figure:

- the vertical axis shows the real price of traded goods = the inverse of the exchange rate.
  - the supply and demand for foreign currency is initially in balance at  $q_1, e_1$ .
  - if the demand for imports by Australians goes up by  $\Delta D$ , the real price of traded goods will cost more
  - the \$A will devalue in terms of foreign currency as the real price of imports rises (and  $e$  rises)
  - Australian exporters will gain more revenue in \$A terms, to encourage additional exports
- ∴ an upwards sloping supply curve  $S$ .

**Foreign Exchange (cont.)**

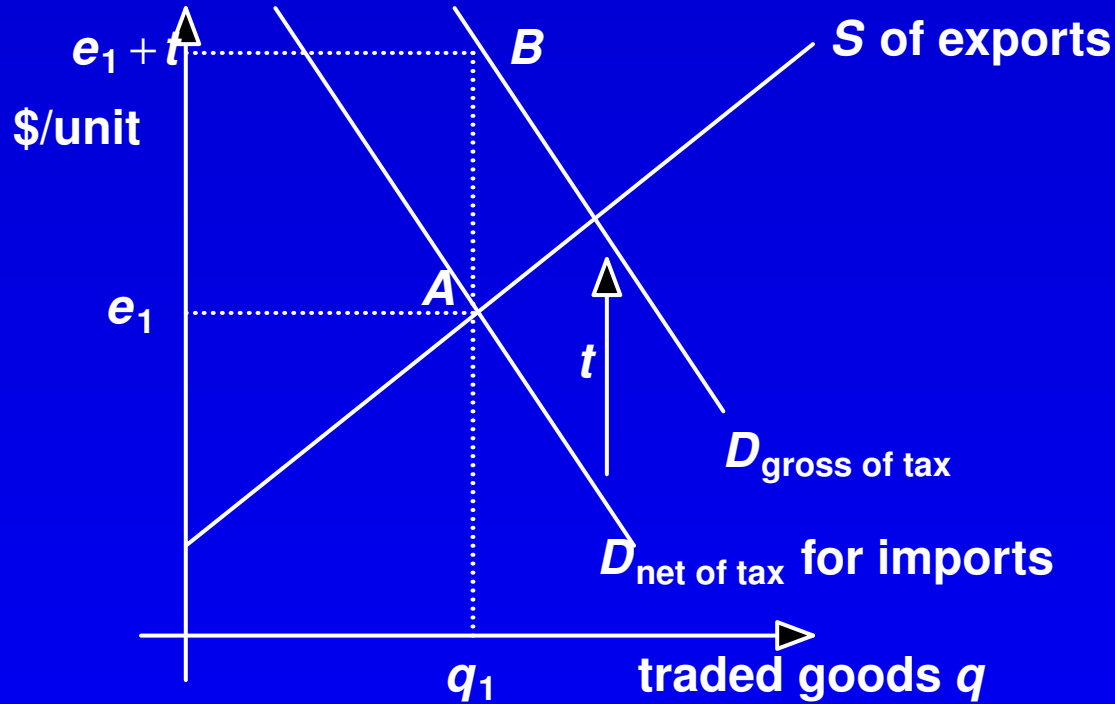

**A tariff (tax) of  $t$  is now imposed on imports**

•

## Foreign Exchange (cont.)

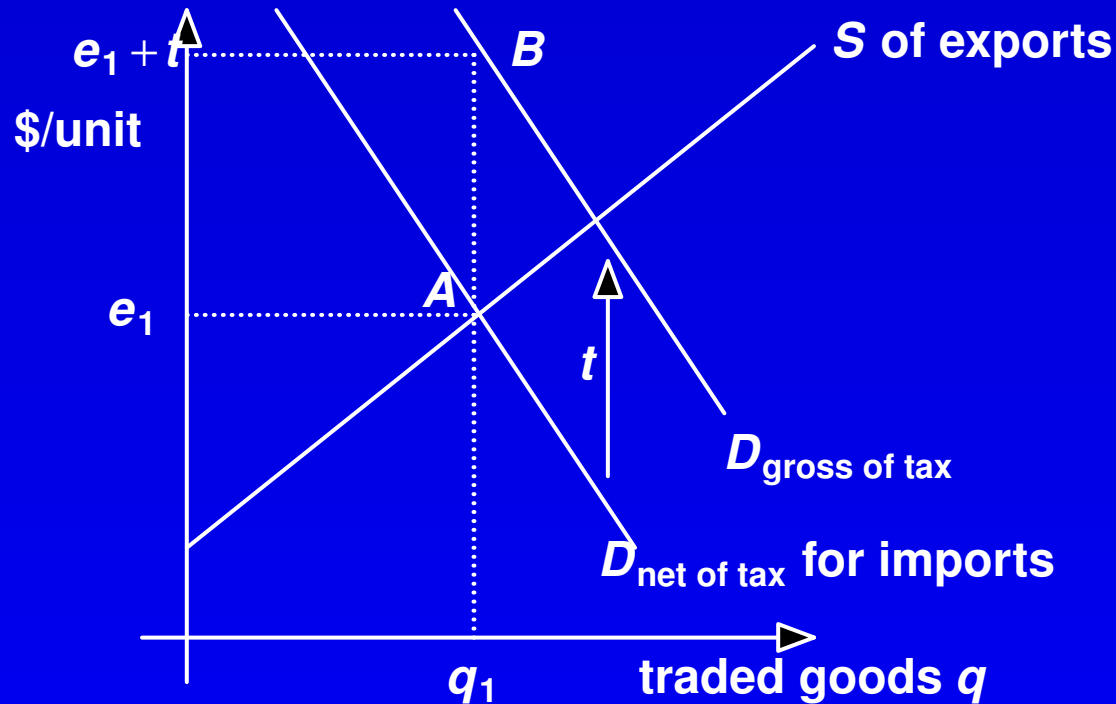

A tariff (tax) of  $t$  is now imposed on imports

- A represents the equilibrium value of exports
-

## Foreign Exchange (cont.)

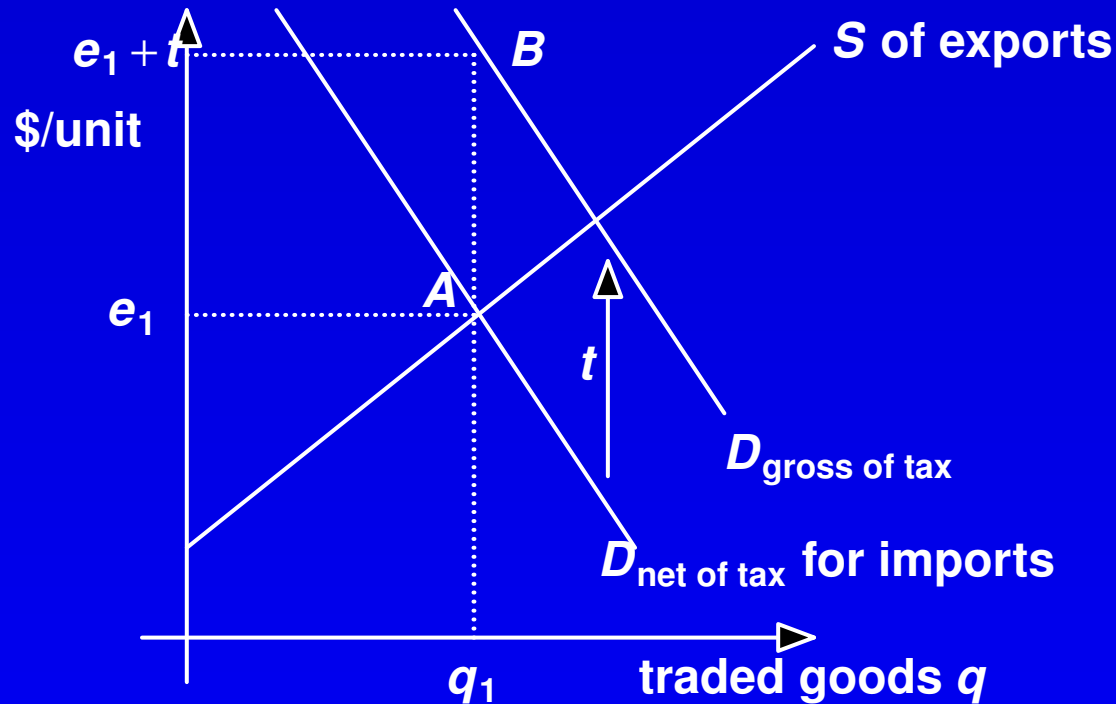

A tariff (tax) of  $t$  is now imposed on imports

- A represents the equilibrium value of exports
- B is the tariff-inclusive value of imports
-

## Foreign Exchange (cont.)

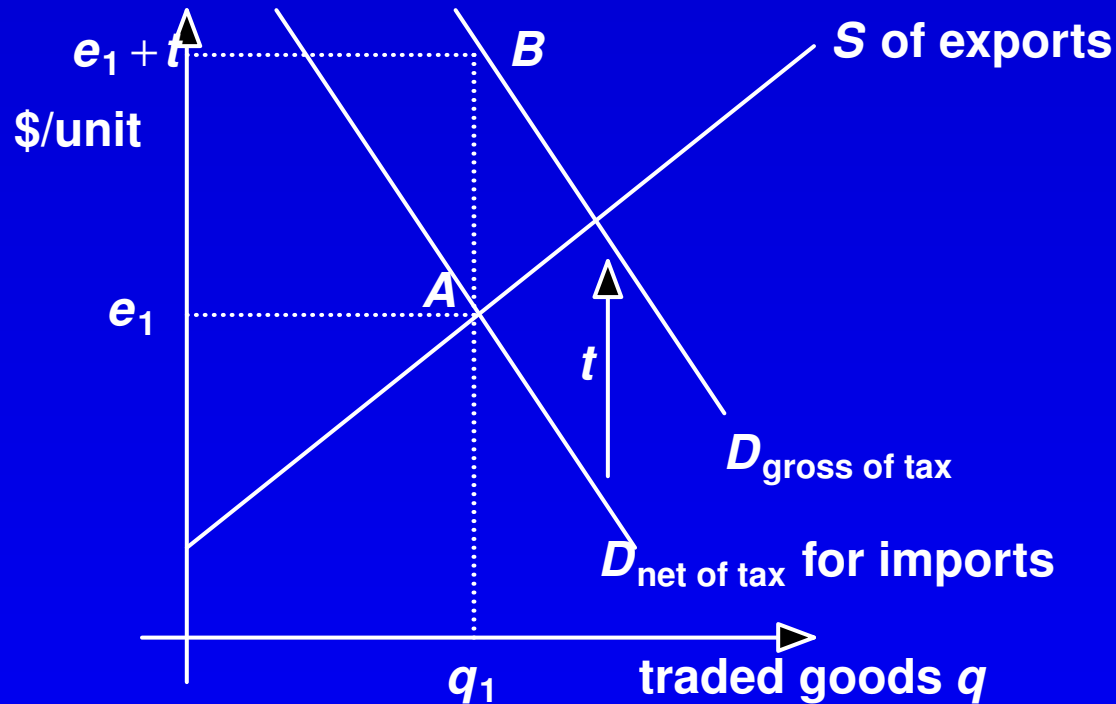

A tariff (tax) of  $t$  is now imposed on imports

- $A$  represents the equilibrium value of exports
- $B$  is the tariff-inclusive value of imports
- measured in terms of foreign currency, the value of imports and exports is equal.

**Foreign Exchange (cont.) —**

Project now increases our supply of foreign exchange  $\Delta S$  via additional exports. Let  $\Delta S = 1$ .

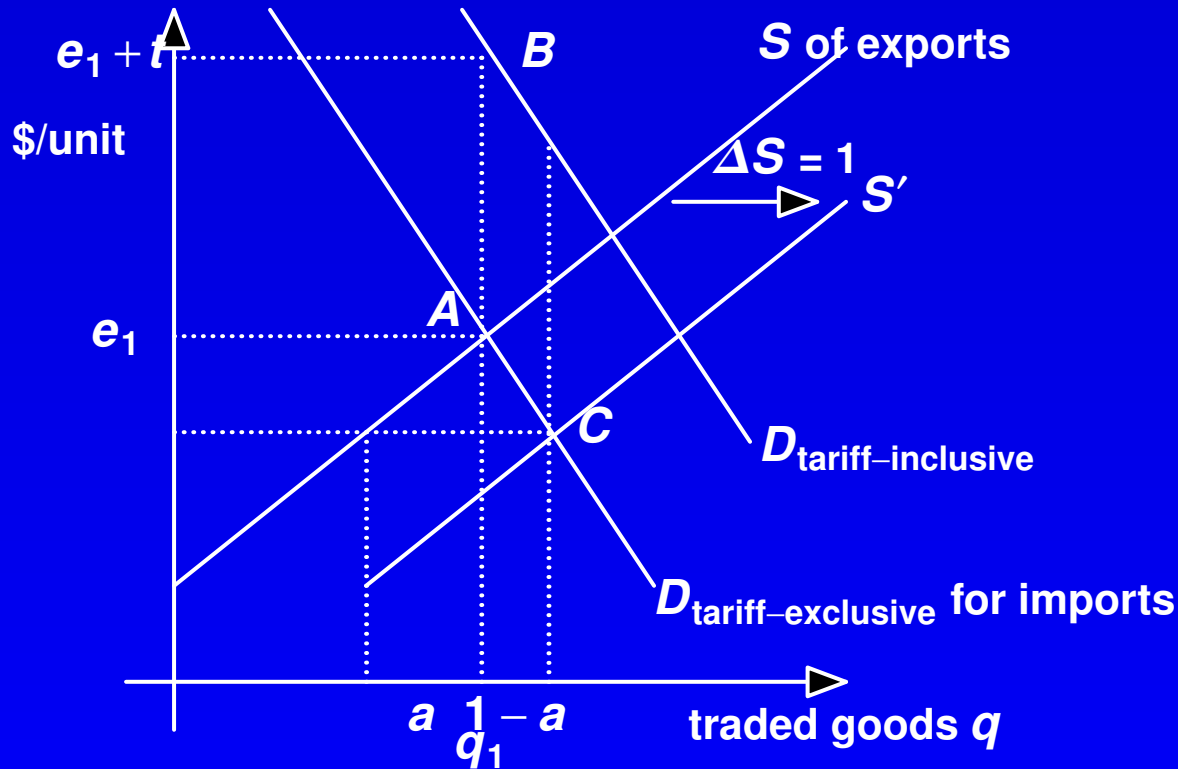

.



**Foreign Exchange (cont.) —**

Project now increases our supply of foreign exchange  $\Delta S$  via additional exports. Let  $\Delta S = 1$ .

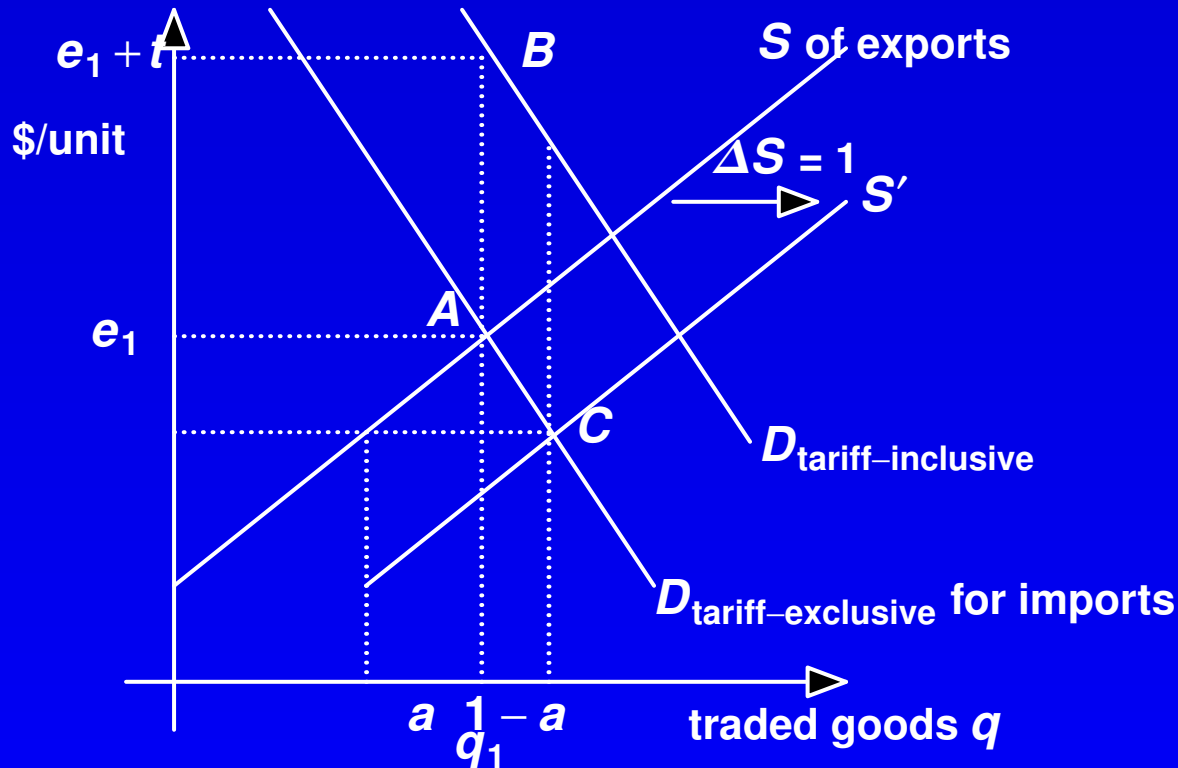

- this situation is similar to the tax example (p.5-12)

---

**Foreign Exchange (cont.) —**

-

**Foreign Exchange (cont.) —**

- increased exports facilitates increased imports valued at  $e_1 + t$   
(area base  $1 - a$ )
-

**Foreign Exchange (cont.) —**

- increased exports facilitates increased imports valued at  $e_1 + t$  (area base  $1 - a$ )
- increased new exports displaces traditional exports  $a$  valued at net-tax price of  $e_1$
-

**Foreign Exchange (cont.) —**

- increased exports facilitates increased imports valued at  $e_1 + t$  (area base  $1 - a$ )
- increased new exports displaces traditional exports  $a$  valued at net-tax price of  $e_1$
- shadow price =

**Foreign Exchange (cont.) —**

- increased exports facilitates increased imports valued at  $e_1 + t$   
(area base  $1 - a$ )
- increased new exports displaces traditional exports  $a$  valued at net-tax price of  $e_1$
- shadow price =  $a$  (post-tax price of traded goods)  
+  $(1 - a)$ (pre-tax price of traded goods)
-

**Foreign Exchange (cont.) —**

- increased exports facilitates increased imports valued at  $e_1 + t$  (area base  $1 - a$ )
- increased new exports displaces traditional exports  $a$  valued at net-tax price of  $e_1$
- shadow price =  $a$  (post-tax price of traded goods)  
+  $(1 - a)$ (pre-tax price of traded goods)
- shadow exchange rate will exceed market exchange rate, since exports are under-valued by the market exchange rate. — The Gregory Thesis or Dutch Disease.

## Summary of Lecture 5

This lecture introduced the use of market prices — suitably adjusted to become *shadow prices* which accurately reflect the opportunity cost of the goods and services used by the project, whether produced in response to the project's demand (*incremental*) or bid away from existing uses (*displaced*) — in CBA studies.

Remember: **No price change  $\therefore$  no displacement**

-



## Summary of Lecture 5

This lecture introduced the use of market prices — suitably adjusted to become *shadow prices* which accurately reflect the opportunity cost of the goods and services used by the project, whether produced in response to the project's demand (*incremental*) or bid away from existing uses (*displaced*) — in CBA studies.

Remember: **No price change ∴ no displacement**

- How to adjust market prices for taxes (which are *transfers*, by and large).
-

## Summary of Lecture 5

This lecture introduced the use of market prices — suitably adjusted to become *shadow prices* which accurately reflect the opportunity cost of the goods and services used by the project, whether produced in response to the project's demand (*incremental*) or bid away from existing uses (*displaced*) — in CBA studies.

Remember: **No price change ∴ no displacement**

- How to adjust market prices for taxes (which are *transfers*, by and large).
- How to adjust market prices for price changes caused by the project.  
When input prices rise, FA overstates the cost.  
When output prices fall, FA understates the benefit.

-

## Summary of Lecture 5

This lecture introduced the use of market prices — suitably adjusted to become *shadow prices* which accurately reflect the opportunity cost of the goods and services used by the project, whether produced in response to the project's demand (*incremental*) or bid away from existing uses (*displaced*) — in CBA studies.

Remember: **No price change ∴ no displacement**

- How to adjust market prices for taxes (which are *transfers*, by and large).
- How to adjust market prices for price changes caused by the project.  
When input prices rise, FA overstates the cost.  
When output prices fall, FA understates the benefit.
- How to adjust market prices for regulated prices, such as minimum wages with unemployment among the workers the project will hire.  
Shadow wages.